



# ***INSTALLATION MANUAL***

## **FREESTYLE EVOLUTION**

### **CAREFREE STYLE CODE “IJ”**

#### **RV**

#### **12V MOTORIZED ROOF MOUNTED BOX AWNING**



Read this manual before installing or using this product. Failure to follow the instructions and safety precautions in this manual can result in personal injury and/or cause the product to not operate properly.



### **TABLE OF CONTENTS**

<b>Product Overview</b> .....	<b>4</b>
Component Checklist.....	5
Freestyle RM Bracket Kits .....	5
<b>Installation</b> .....	<b>7</b>
Bracket Installation .....	7
Mounting the Awning .....	7
Jumping the Motor (with BT12).....	7
<b>Controller Installation</b> .....	<b>8</b>
<b>Switch Installation</b> .....	<b>9</b>
Awning Switch Installation .....	10
Awning Lights Switch Installation .....	10
Wiring Diagram.....	11
<b>Pitch Adjustment</b> .....	<b>13</b>
<b>Adjusting the Extend Limit</b> .....	<b>13</b>
<b>Manual Override</b> .....	<b>13</b>

## **NOTICES AND DISCLAIMERS**

### **TRADEMARKS**

The **Bluetooth®** word mark and logos are registered trademarks owned by the Bluetooth SIG, Inc. Use of such marks by Carefree of Colorado is under license.

Other trademarks and trade names are those of their respective owners.

### **STATEMENTS OF COMPLIANCE**

- BT12 Control Module
- BT Motion Sensor
- BT Remote

The DRCHUB contains transmitter module FCC ID:2AA9B04; IC:12208A-04.

FCC and IC identification numbers are located on the exterior surfaces of the individual components.

#### ***FCC COMPLIANCE***

These devices comply with Part 15 of the FCC rules. Operation is subject to the following two conditions: (1) These devices may not cause harmful interference and, (2) These devices must accept any interference received, including interference that may cause undesired operation.

NOTE: This equipment has been tested and found to comply with the limits for a Class B digital device, pursuant to part 15 of the FCC rules. These limits are designed to provide reasonable protection against harmful interference in a residential installation. This equipment generates, uses and can radiate radio frequency energy and, if not installed and used in accordance with the instructions, may cause harmful interference to radio communications. However, there is no guarantee that interference will not occur in a particular installation. If this equipment does cause harmful interference to radio or television reception, which can be determined by turning the equipment off and on, the user is encouraged to try to correct the interference by one or more of the following measures:

- Reorient or relocate the receiving antenna.
- Increase the separation between the equipment and receiver.
- Connect the equipment into an outlet on a circuit different from that to which the receiver is connected.
- Consult the dealer or an experienced radio/TV technician for help.

Any changes or modifications not expressly approved by the party responsible for compliance could void the user's authority to operate the equipment.

#### ***IC COMPLIANCE***

These devices comply with Industry Canada license-exempt RSS standard(s). Operation is subject to the following two conditions: (1) These devices may not cause harmful interference and, (2) These devices must accept any interference received, including interference that may cause undesired operation.

Ces appareils sont conformes aux normes RSS exonérées de licence d'Industrie Canada. L'opération est soumise aux deux conditions suivantes: (1) Ces appareils ne doivent pas causer d'interférences nuisibles et, (2) Ces appareils doivent accepter toute interférence reçue, y compris les interférences pouvant entraîner un fonctionnement indésirable.

#### ***FCC/IC RADIATION EXPOSURE STATEMENT***

- BT12 Control Module
- BT Motion Sensor
- DRC12 Control Module

This equipment complies with FCC and IC radiation exposure limits for an uncontrolled environment. The minimum distance between the radiator and people is designed to be 20cm when installed and operated.

Cet équipement est conforme aux limites d'exposition aux radiations FCC et IC pour un environnement non contrôlé. La distance minimale entre le radiateur et les personnes est de 20cm lorsqu'installé et utilisé.

- BT12 Remote

This equipment complies with FCC and IC radiation exposure limits for an uncontrolled environment. The minimum distance between the radiator and people is designed to be 5mm when operated.

Cet équipement est conforme aux limites d'exposition aux radiations FCC et IC pour un environnement non contrôlé. La distance minimale entre le radiateur et les personnes est de 5mm (à l'exclusion des extrémités: mains, poignets, pieds et chevilles) lors de l'utilisation.

## DISCLAIMERS

The BT12, DRC12 and the Carefree Connects Mobile Apps are products of Carefree of Colorado, located in Broomfield, Colorado, USA. The information contained in or disclosed in this document is considered proprietary to Carefree of Colorado. Every effort has been made to ensure that the information presented in the document is accurate and complete. However, Carefree of Colorado assumes no liability for errors or for any damages that result from the use of this document.

The information contained in this manual pertains to the current components and software listed on the title page. Carefree of Colorado reserves the right to cancel, change, alter or add any parts and procedures, described in this manual, without prior notice.

Carefree of Colorado agrees to allow the reproduction of this document for use with Carefree of Colorado products only. Any other reproduction or translation of this document in whole or part is strictly prohibited without prior written approval from Carefree of Colorado.

## SERVICE AND SUPPORT

	<a href="http://www.carefreeofcolorado.com">www.carefreeofcolorado.com</a> <a href="http://www.carefreeofcolorado.com/rv-products/carefree-connects/">www.carefreeofcolorado.com/rv-products/carefree-connects/</a>
	<a href="mailto:customerservice@carefreeofcolorado.com">customerservice@carefreeofcolorado.com</a>
	Carefree of Colorado 2145 W. 6 <sup>th</sup> Ave. Broomfield, CO 80020

## SAFETY INFORMATION



This is the safety alert symbol. It is used to alert individuals to potential personal injury hazards. Obey all safety messages that follow this symbol to avoid possible personal injury or death.



Indicates a hazardous situation, which if not avoided, could result in death or serious bodily injury.



Indicates a hazardous situation, which if not avoided, may result in minor or moderate bodily injury.



Indicates a situation that may result in equipment-related damage.

### General Safety:



This product can expose you to chemicals including Di-isodecyl phthalate (DIDP), Vinyl Chloride and Formaldehyde, which are known to the state of California to cause cancer or birth defects or other reproductive harm. For more information visit [www.P65warnings.ca.gov](http://www.P65warnings.ca.gov)



Shock Hazard. Always disconnect battery or power source before working on or around the electrical system.



Always wear appropriate safety equipment (i.e. goggles).



Always use appropriate lifting devices and/or helpers when lifting or holding heavy objects.



When using fasteners, do not over tighten. Soft materials such as fiberglass and aluminum can be "stripped out" and lose the ability to grip and hold.

## PRODUCT OVERVIEW

The Freestyle Evolution Awning is a state of the art lateral arm awning. When retracted, the housing provides protection against the elements while the streamlined styling blends in with the vehicle appearance. The full tension canopy fabric allows the awning to be partially or fully extended for best shade coverage.

Each unit is equipped with lateral support arms. No vertical arms interfere with coach sidewalls, custom graphics or equipment that may be mounted on the sidewalls.

### Freestyle Awning Specifications:

- Fully retractable and self-storing;
- The awning controls operate on standard 12VDC (range 10VDC to 15VDC required);
- Case and frame are constructed of high-strength aluminum extrusions, protected with a polyester paint finish;
- BT12 Wireless Awning Control System is standard.

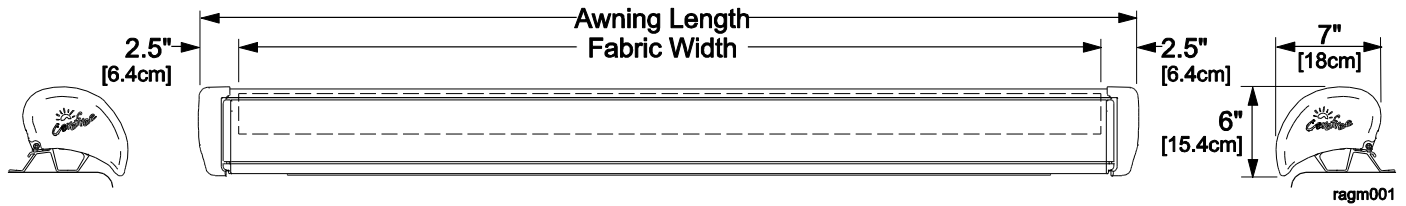

NOTE: Dimensions shown are approximate. Dimensions may vary based on specific installations.

### SPECIFICATIONS

Lengths:	centimeters	200 - 241	244 - 254	257 - 297	300 - 500
	inches	79 - 95	96 - 100	101 - 117	118 - 197
Extension:		152cm (60")	180cm (72")	200cm (80")	250cm (98")

### LEADING EDGE POSITION ACTUATION AND CONTROL

Power:	Lateral Arm Spring	Minimum Tension	Open
Position Control:	12V Motorized		
Controller:	BT12, DRC12		

### MOTOR SPECIFICATIONS

Motor Type:	Tubular, Right Angle Gear Motor		
Power:	12VDC	Minimum: 10VDC	Output: 30 Watts
		Nominal Current: 2.5Amps	Max Current: 14Amps (stall @ min voltage)
Power Source:	Motor and controls are routed and hardwired into the vehicle's 12V system		
Torque	Continuous: 6Nm/4.5 ft-lbs.		
Speed	24 rpm		

### COLORS AVAILABLE

Case	Satin, White or Black
Fabric: <sup>1</sup>	Vinyl or Woven Acrylic

**Special Note: Dimensions are provided in centimeters. Conversion formulas are provided below;**

$$\text{Inches} = \frac{\text{Centimeters}}{2.54} = \frac{\text{Millimeters}}{25.4}$$

$$\text{Centimeters} = \text{Inches} \times 2.54 \quad \text{Millimeters} = \text{Inches} \times 25.4$$

# COMPONENT CHECKLIST

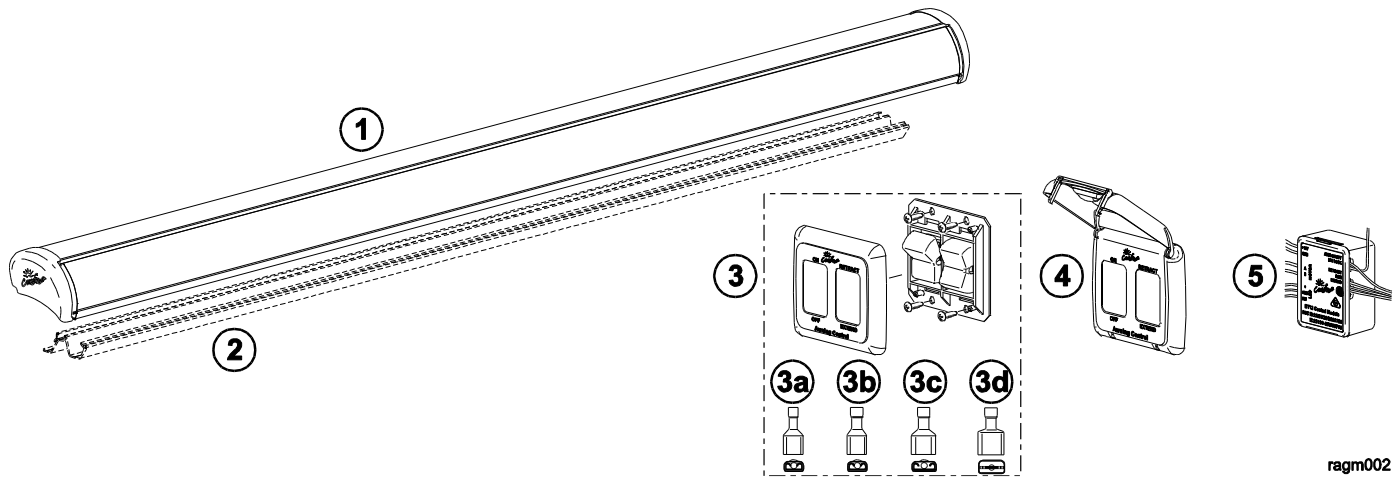

ragm002

ITEM	DESCRIPTION	QTY	NOTE
<input type="checkbox"/> 1	Awning Assembly, Complete	1	
<input type="checkbox"/> 2	Mounting Bracket <span style="float: right;">Ordered Separately, Refer to "Freestyle RM Bracket Kits"</span>		
<input type="checkbox"/> 3	Switch Kit	1	
<input type="checkbox"/> 3a	Terminal, Female, .187	18-22 awg	3
<input type="checkbox"/> 3b	Terminal, Female, .187	14-16 awg	2
<input type="checkbox"/> 3c	Terminal, Female, .25	14-16 awg	1
<input type="checkbox"/> 3d	Terminal, Male, .25	14-16 awg	1
<input type="checkbox"/> 4	Covered Bezel, 2 Switch	1	2
<input type="checkbox"/> 5	Control Module (BT12 included, DRC12 separate)	1	3

- NOTES:
- Specific awning configuration is specified at time of order, including awning length, fabric, color etc. check awning assembly against original purchase order.
  - The covered bezel (item 4) is optional and ordered separately. Refer to page 8 for information about NFPA 1192 RV Standard, Section 6.4.9 (Switch Installation Requirements).
  - The Motion Sensor is factory installed in the lead rail on the motor side.

## FREESTYLE RM BRACKET KITS

Bracket kits are ordered separately. Several types are available based on the application installation. Bracket mounting instructions are separate instructions that supplement this manual.

### BS0012

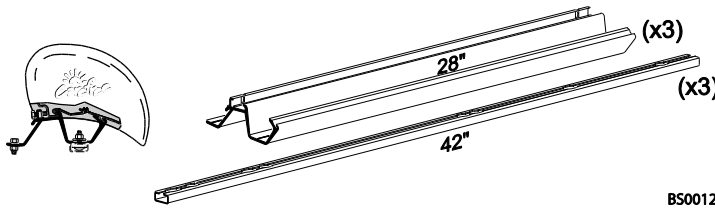

BS0012a

**Sprinter**  
4.5m & 5m

Mill Finish  
Bracket and Awning Hardware included  
Instruction Supplement: 052570-012

### BS0013

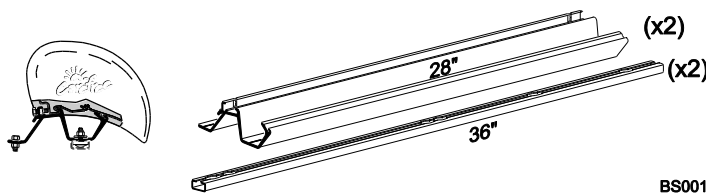

BS0013a

**Sprinter**  
4m and less

Mill Finish  
Bracket and Awning Hardware included  
Instruction Supplement: 052570-013

### BS0014

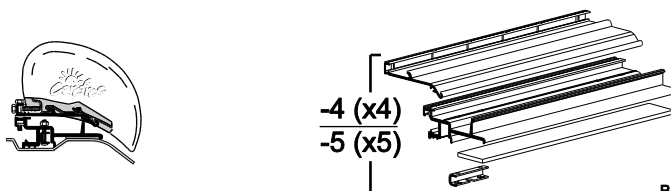

BS0014a

**Dodge ProMaster; Fiat Ducato**  
(-4) 4 Brackets 3.5m  
(-5) 5 Brackets 4m

Mill Finish  
Bracket and Awning Hardware included  
Instruction Supplement: 052570-014

**BS0016**

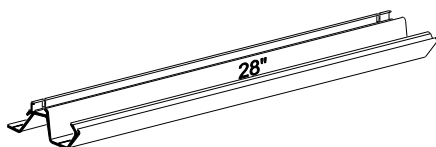
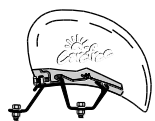

BS0016a

**Flat Roof**

- (-3) 3 Brackets 4m
- (-4) 4 Brackets 4.5m & 5m

Mill Finish  
Bracket and Awning Hardware included  
Instruction Supplement: 052570-016

**BS0017**

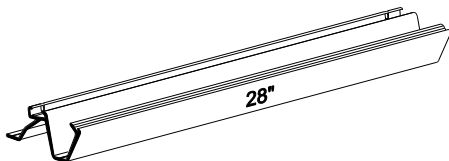

BS0017a

**Sprinter – No Rail**

- (-28-2) 2 Brackets up to 4m

Mill Finish  
Bracket and Awning Hardware included  
Instruction Supplement: 052570-017

**FULL LENGTH BRACKETS**

**BS0015**

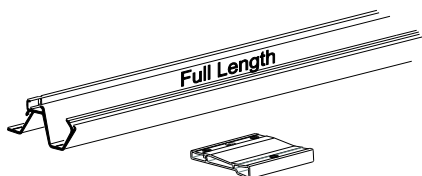
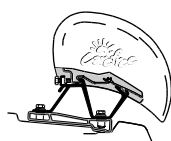

BS0015a

**Ford Transit**

- (-118-XX) Full Length 3m
- (-138-ML) Full Length 3.5m
- (-157-XX) Full Length 4m
- Mill (ML) or Black (JV) Finish
- Bracket and Awning Hardware included
- Instruction Supplement: 052570-015

**BS0018**

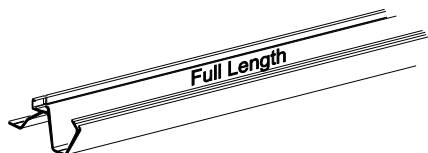

BS0018a

**Sprinter – No Rail**

- (-118-XX) Full Length 3m
- (-157-XX) Full Length 4m
- (-177-XX) Full Length 4.5m
- Mill (ML) or Black (JV) Finish
- Bracket and Awning Hardware included
- Instruction Supplement: 052570-018

**BS0019**

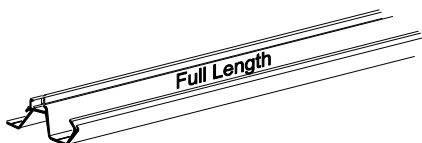

BS0019a

**Sprinter used w/ OEM Rail or Flat Roof**

- (-118-XX) Full Length 3m
- (-157-XX) Full Length 4m
- (-197-XX) Full Length 5m
- Mill (ML) or Black (JV) Finish
- Bracket and Awning Hardware included
- Instruction Supplement: 052570-019

**BS0021**

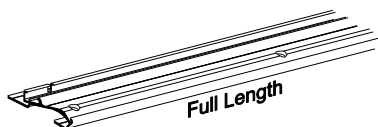

BS0021a

**Low Profile RM Mounting Bracket Kit**

- (-157-ML) Full Length 4m
- (-177-XX) Full Length 4.5m

Mill (ML) or Black (JV) Finish  
Bracket and Awning Hardware included  
Instruction Supplement: 052570-021

**BS0023**

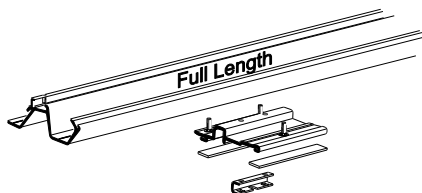
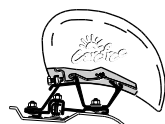

BS0023a

**Dodge ProMaster**

- (-157-XX) Full Length 4m

Mill (ML) or Black (JV) Finish  
Bracket and Awning Hardware included  
Instruction Supplement: 052570-023

## INSTALLATION

### BRACKET INSTALLATION

Install the mounting brackets according to the supplement instructions for the bracket kit.

**NOTE:** Install the brackets according to the bracket design. To correctly support the awning, the brackets must be positioned below the arm case knuckles. After the brackets are installed, go to "Mounting the Awning".

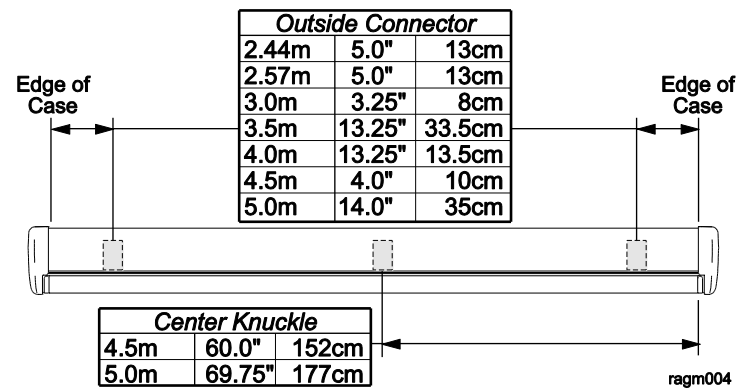

### MOUNTING THE AWNING

These steps apply to all bracket configurations.

1. If not previously done, in the rear track of the mounting plate(s), start three (3) M6 (Length depends on kit) screws and square nuts through the holes. Do not tighten at this time.

**NOTE:** Locate 1 screw and nut at each end of the awning, the third screw and nut should be located near the center of the awning.

2. Lift and set the awning into the hooks of the mounting brackets. Pull the case forward to engage the brackets fully.
3. Horizontally center the awning on the brackets.
4. Tighten the rear screws. Torque to 25-30 in-lbs [2.8 - 3.4 nm].
5. The motor and switch wires come out of the back of motor endcap. Drill a 5/16" [8mm] hole into the vehicle in the area shown.

**NOTE:** Locate the hole to avoid interior framing, cabinets and electrical components.

Ensure that the motor wires are accessible after routing.

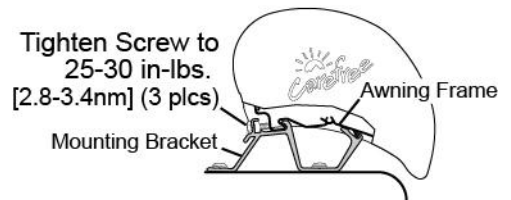
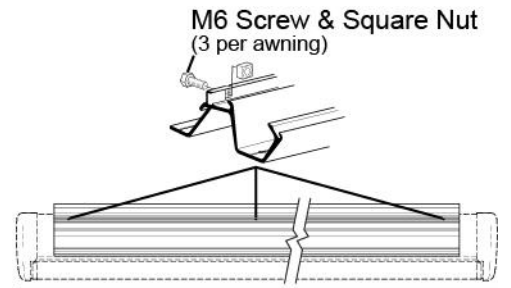

Align Hole with Edge of Endcap and Slightly Behind Awning

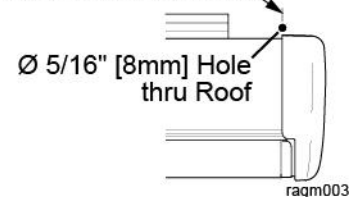

### Jumping the Motor (with BT12)

This method is used if the BT12 Wireless Awning Control System is to be used.

1. Temporarily connect the ends of the motor wires to a 12V-14V source (i.e. drill battery). If the awning does not begin to move, reverse the leads.
2. Remove the battery after the awning is open.

## **CONTROLLER INSTALLATION**



If installing the DRC12 Wireless Awning Control System, use the wiring and setup instructions in "070040-006 DRC Awning Control System".

Manual is available on-line at [www.carefreeofcolorado.com](http://www.carefreeofcolorado.com)



If installing the BT12 Wireless Awning Control System use the wiring and setup instructions in "070029-001 BT12 Wireless Awning Control System".

Manual is available on-line at [www.carefreeofcolorado.com](http://www.carefreeofcolorado.com)



**WARNING** Shock Hazard. Always disconnect battery or power source before working on or around the electrical system.

## **SWITCH INSTALLATION**

**NOTICE** To comply with 2018 NFPA 1192 RV Standard, Section 6.4.7, switches must be mounted as follows:

For travel trailers and 5<sup>th</sup> wheels:

- a) Installed in a dedicated switch cabinet with a latching door; or,
- b) Installed with the optional covered bezel available from Carefree; or,
- c) Installed in a cabinet with a latching door where the switch is protected and CANNOT be activated by any items or cargo that may move or shift during transit; or,
- d) Installed with an interrupt circuit that disables awning extension when the vehicle is in motion (i.e. a relay tied into the parking brake or ignition that disconnects the BROWN extend wire).

In addition to the above options to satisfy NFPA requirements, an on/off switch or relay must also be used on the Violet "AWN ON/OFF" wire which is a Carefree requirement.

For motorized coaches (Class A, Class B or Class C):

- a) Installed with an interrupt circuit connected to the "IGN LOCK" (green wire) option.

In addition to using an interrupt circuit on "IGN LOCK" to satisfy NFPA requirements, an on/off switch or relay must also be used on the Violet "AWN ON/OFF" wire which is a Carefree requirement.

### ***To Start:***

1. Determine the location for the awning switches, awning lights switch and control module.
2. Route the motor cable and LED harness to the location of the module.

### AWNING SWITCH INSTALLATION

(Refer to the wiring diagram on page 11.)

1. At the switch location cut a 2.32" x 1.5" hole.
2. From the module, terminate the three (3) 20awg wires (Brown, Yellow and Gray) with .187, 18-20 awg female terminals. Attach to the EXTEND/RETRACT switch as shown in the wiring diagram.
3. From the module, terminate the Violet wire with a .187, 18-20 awg female terminal. Attach to the ON/OFF switch.
4. Run a minimum 14 awg wire to +12VDC. Terminate the wire with .187, 14-16 awg female terminal and connect to the second terminal of the ON/OFF switch.

**NOTE:** If the wire run is 30 feet or longer, use 12awg wire to prevent voltage drop. Use the appropriate wire terminals for the wire size.

5. Push the wires and switches into the hole then attach the switch frame using 4 #6 x 1/2" screws.
6. Snap the switch bezel over the switch frame.

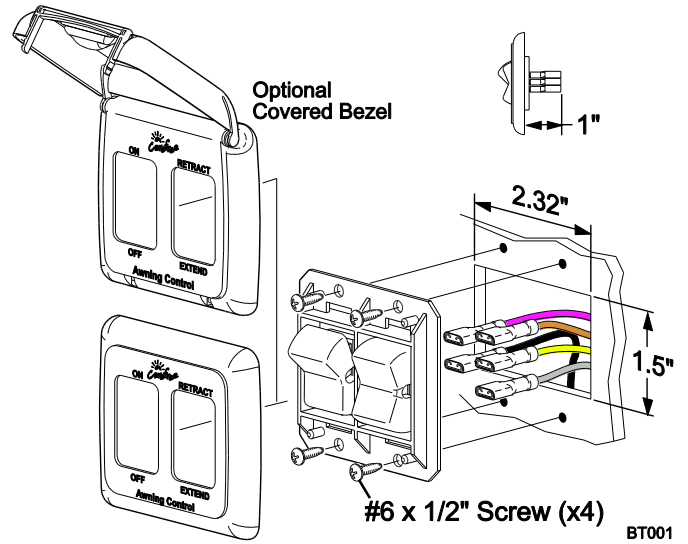

### AWNING LIGHTS SWITCH INSTALLATION

**NOTE:** Installers may choose to furnish the control switch or may wire directly to a multiplexing control center.

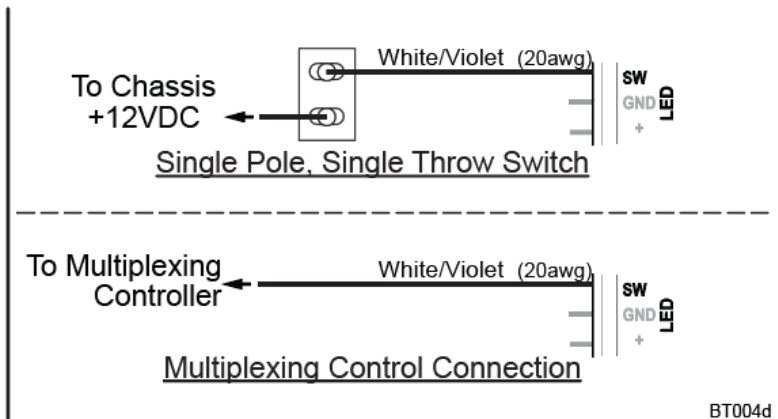
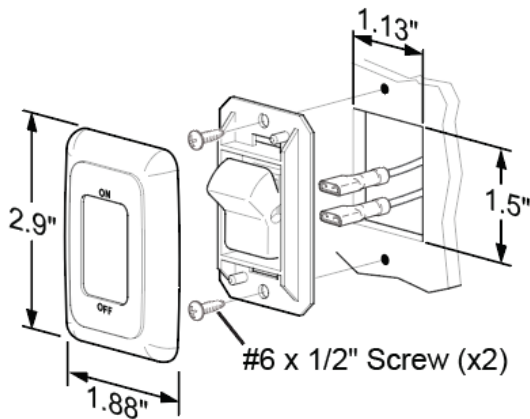

1. Determine the location of the switch.
2. At the switch location, cut a 1.13" x 1.5" hole.
3. Wire the switch as shown. Wire terminals at the switch are .187, 18-24 awg female disconnects.
4. Press the wires and switch into the mounting hole. Secure the switch using two (2) #6 x 1/2" screws.
5. Snap the switch bezel over the switch frame.

**WIRING DIAGRAM**

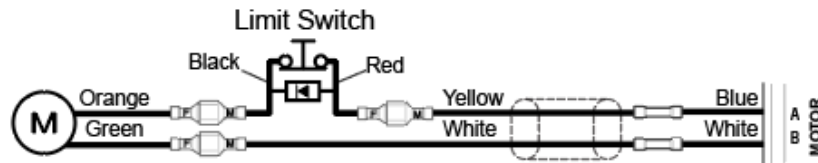

Right Angle Gear Motor (typical for LH and RH Installations)

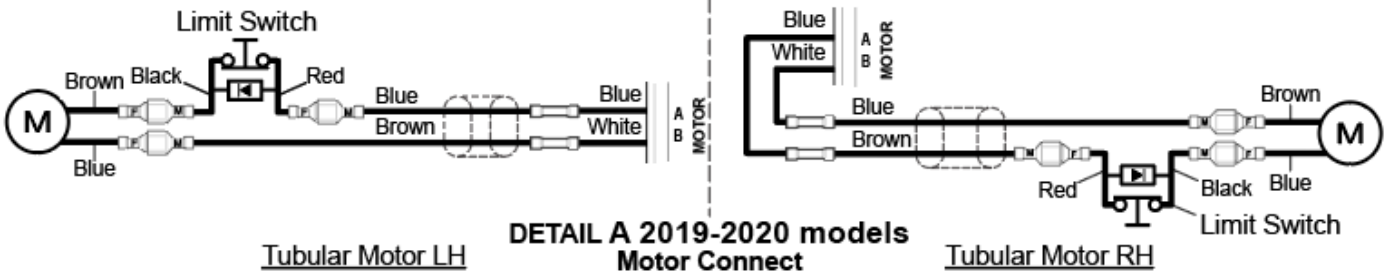

Tubular Motor LH

**DETAIL A 2019-2020 models**  
**Motor Connect**

Tubular Motor RH

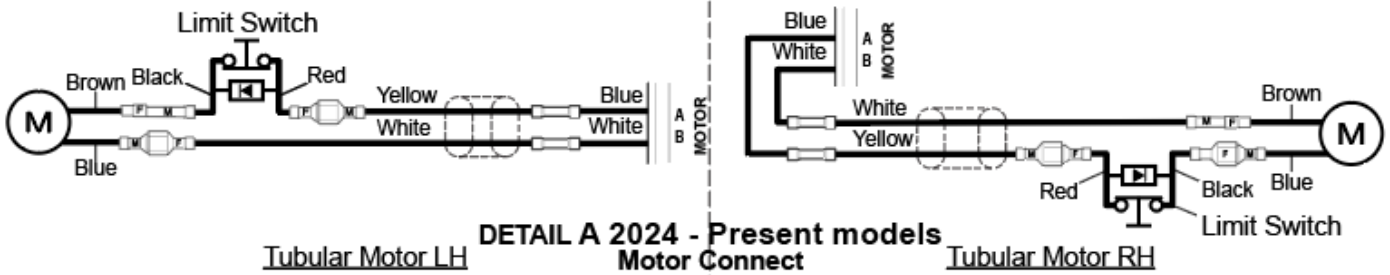

Tubular Motor LH

**DETAIL A 2024 - Present models**  
**Motor Connect**

Tubular Motor RH

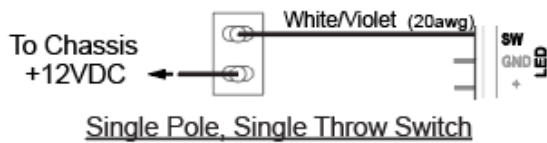

Single Pole, Single Throw Switch

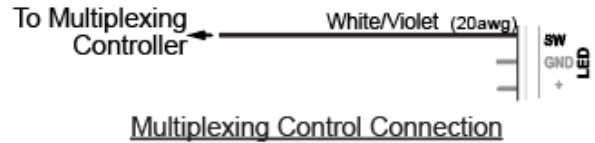

Multiplexing Control Connection

FE001

- 
- 1** For GND, run a minimum 14 awg wire to chassis ground. Suitable ground would be the vehicle chassis or conductive structure connected to the chassis.

For +12Vdc, Run a minimum 14 awg wire from the power distribution panel (chassis battery circuit) or equivalent. The circuit should be protected by a 15-amp fuse.

**NOTE:** If the wire run is 30 feet or longer, use 12awg wire to prevent voltage drop. Use the appropriate wire terminals for the wire size.

---

  - 2** The LED connection is optional to provide LED controls through the app for white LEDS only. White LEDS can also be installed per the standard LED installation without BT12 Controls. RGB lights must be installed per the standard RGB installation.

---

  - 3** Carefree LED lights uses a 2 amp circuit draw. If using a different brand of high output LED's that draws more than 2 amps, the lights will flicker and not perform as expected.

---

  - 4** The awning disable switch is a single throw; single pole switch used with OEM Multiplexing Control Systems. Switch is furnished by installer.
-

## **PITCH ADJUSTMENT**

The awning opens and closes with a steep pitch. On low profile vans, the leading edge of the awning may hit the top of the sliding door if the door is open while extending or retracting the awning. To prevent this, the lower limit of the pitch can be adjusted upwards. The minimum acceptable pitch is 10 degrees from horizontal.

1. Open the awning to access the screws located on the side of the arm case knuckles.
2. For Original Configurations:
  - 2.1. Using an 8mm allen wrench, loosen the 2 screws on the side of the case connector.
  - 2.2. Have a second person lift the lead rail to the desired height.
  - 2.3. When the pitch is set at the desired angle, tighten the screws. Torque to 50 ft-lbs.
3. For Current Configurations:
  - 3.1. Loosen the screw on the side of the case connector.
  - 3.2. Turn the 10mm (5mm allen wrench) clockwise to raise the pitch or counterclockwise to lower the pitch.  
*Tip: When raising the pitch have a second person lift up on the lead rail.*
  - 3.3. When the pitch is set at the desired angle, tighten the screw. Torque to 25-30 ft-lbs.
4. Repeat for each arm. Ensure that the lead rail is parallel with the awning case.

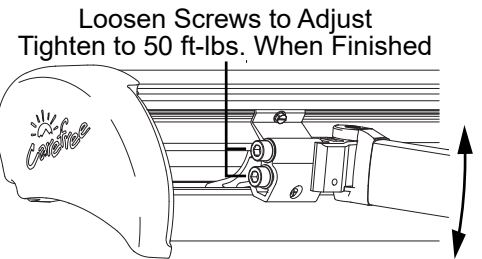

Original Configuration

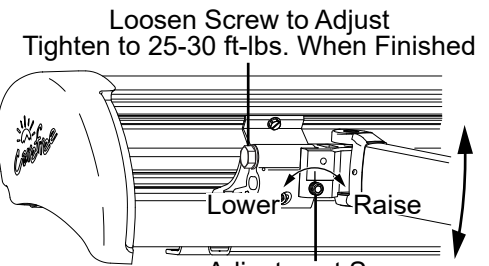

Current Configuration

ragm005

**NOTE:** The lead rail is self-adjusting. No adjustment is required to the lead rail when the pitch is changed.

## **ADJUSTING THE EXTEND LIMIT**

The extend limit switch disables the extend function when the awning is fully extended. This prevents the awning from overextending and can be adjusted so that the canopy is tight when the awning is extended.

The switch is located on the arm knuckle closest to the motor (i.e. right knuckle for RH motor, left knuckle for LH motor).

To adjust the extension:

1. Open the awning to access the switch.
2. Loosen the screw.
3. Move the switch toward the arm to decrease the extension.
4. Move the switch away from the arm to increase the extension.

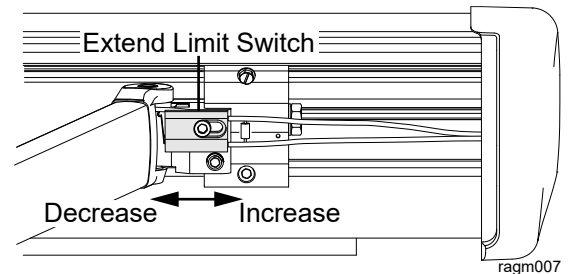

ragm007

## **MANUAL OVERRIDE**

If power to the vehicle is not available, the awning can be safely retracted using the manual override located on the idler end of the case.

**NOTE:** This procedure cannot be used to extend the awning.

1. Remove the outer endcap on the idler side and save.
2. Insert a 3/8" socket drive extension and handle into the square drive hole inside the inner end cap.
3. Turn the handle to match the direction arrows until the awning is retracted.
4. Replace the outer cap.

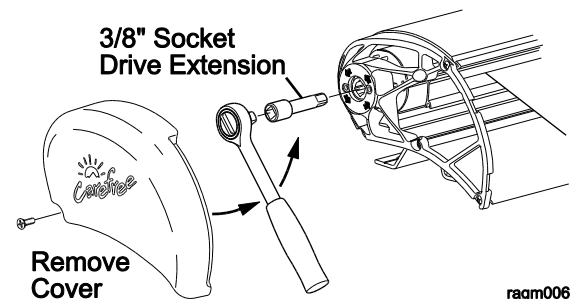

ragm006

**NOTICE** After closing the awning with the manual override, the lead rail may move out from the case 1/4" -1/2". This is normal and the awning is secure for travel until power is restored or repairs

are completed. Do not attempt to force the lead rail in with the override, serious damage can occur to the awning.



**OEM INSTALLATION AUDIT/APPROVAL FORM**

OEM NAME: \_\_\_\_\_ LOCATION OR PLANT #: \_\_\_\_\_

AUDIT RSM: \_\_\_\_\_ DATE: \_\_\_\_\_

UNIT #: \_\_\_\_\_ COACH MODEL: \_\_\_\_\_

PRODUCT DESCRIPTION: \_\_\_\_\_

AWNING SERIAL NUMBER / DATE CODE: \_\_\_\_\_

**CONFIRM ALL OF THE INSTALLATION SECTIONS ARE BEING ACCOMPLISHED. NOTE DESCREPANCIES BELOW.**

Use the space below to note any observations and deviations from this installation manual related to the installation.

\_\_\_\_\_  
\_\_\_\_\_  
\_\_\_\_\_  
\_\_\_\_\_  
\_\_\_\_\_  
\_\_\_\_\_  
\_\_\_\_\_  
\_\_\_\_\_  
\_\_\_\_\_  
\_\_\_\_\_  
\_\_\_\_\_  
\_\_\_\_\_  
\_\_\_\_\_  
\_\_\_\_\_  
\_\_\_\_\_  
\_\_\_\_\_  
\_\_\_\_\_  
\_\_\_\_\_  
\_\_\_\_\_  
\_\_\_\_\_  
\_\_\_\_\_

A complete wiring diagram is required to be submitted to Carefree for review and approval from the OEM and appended to this approval for motorized installations. Review the above with the appropriate OEM production personnel and have this form signed as recognizing and understanding all discrepancies and

corrective action. Take a picture of this page, noting the revision and part number is visible. Send a PDF to OEMTECHREPORT@carefreeofcolorado.com> including wiring diagram. Leave a copy with the OEM, one copy for RSM files and one copy for OEM Applications Manager.

\_\_\_\_\_  
**OEM Representative (please print)**

\_\_\_\_\_  
**OEM Signature**

\_\_\_\_\_  
**OEM Position**

\_\_\_\_\_  
**Date**

\_\_\_\_\_  
**Carefree Representative (please print)**

\_\_\_\_\_  
**Carefree Signature/Date**

Disclaimer: Carefree performs audits as a service for our customers to help identify situations where installations may not conform to installation instructions, and to identify any potential installation errors. Audits are a random, one-time checkin time and do not verify all the attributes specified in the installation instructions. Carefree cannot be held responsible for any damage or costs as a result of incorrect installation. OEMs must always install products according to installation instructions. This document does not constitute liability or culpability on Carefree’s part for incorrect installations performed by the OEM, dealer, service provider or the consumer.