



OWNER'S MANUAL

FREEDOM WM AWNING

Product style codes: GU, 35

*MOTORIZED OR MANUAL LATERAL ARM
BOX AWNING*



Before operating the awning, carefully review the Owner's Manual. The manual contains important safety information, detailed operating instructions, common maintenance procedures and other useful information.



Table of Contents

Operation	3
Motorized Awnings:	3
Manually Operated Awnings:.....	3
Vertical Support Legs	4
Awning Care	5
Fabric Care.....	5
Support Arm Care	5
Arm Noise.....	6
Manual Override (motorized versions only).....	6
Carefree Major Product Limited Warranty.....	7

About Carefree

From its beginning in the early 70's, Carefree of Colorado has emerged as the premier manufacturer of quality awnings and accessories for Recreational Vehicles (RVs). Our full line of products can provide the accessories that match your life style; no matter what type of RV you own. Check with your dealer to discover the products that can make your life more Carefree.

The Carefree Freedom series of awnings are state of the art with lateral support arms that provides strength and functionality without interfering with coach sidewalls, custom graphics or equipment that may be mounted on the sidewalls.

- *When retracted, the housing provides protection against the elements while the streamlined styling blends in with the RV sidewall and is a perfect complement to other Carefree products.*
- *The awnings are made with heavy duty construction including an all metal chassis.*
- *The Freedom WM is available in manually operated or motorized models.*



This is the safety alert symbol. It is used to alert individuals to potential personal injury hazards. Obey all safety messages that follow this symbol to avoid possible personal injury or death.

 **WARNING** This product can expose you to chemicals including Di-isodecyl phthalate (DIDP), Vinyl Chloride and Formaldehyde, which are known to the state of California to cause cancer or birth defects or other reproductive harm. For more information visit www.P65warnings.ca.gov



 **WARNING** Risk of fire. Keep all sources of heat and flame away from the awning canopy. Fabric is NOT fireproof.

NOTICE Awnings are designed to provide shade and protection from the sun. The effects of wind and rain on an awning are unpredictable and can cause severe damage to the awning and/or the vehicle. If wind or extended periods of rain are expected, roll up the awning.

NOTICE It is recommended that if leaving the RV unattended for a length of time, retract the awning to avoid unexpected weather conditions.

NOTICE The vertical support legs provide increased stability but do not compensate for harsh weather conditions such as wind and/or heavy rain. During inclement weather, retract and secure the awning in the travel position.

NOTICE When storing the support legs, make sure that the legs are firmly secured inside the lead rail. Open the latch and spread the channels until tight, then close the latch. If not properly secured the supports can shift and catch inside the awning. This can cause serious damage to the awning.

Additional Cautions and Notices are included in the text for the proper operation of the awning.

OPERATION

MOTORIZED AWNINGS:

Extending the Awning

- Press and hold the switch in the OUT (extend) position until the awning is in the desired position then release the switch.
- Extend and attach the vertical support legs (refer to page 4).

Retracting the Awning

- Detach and stow the vertical support legs.
- To retract the awning, press and hold the switch in the IN (retract) position until the awning is in the desired position then release the switch.

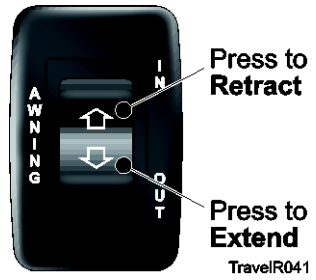

MANUALLY OPERATED AWNINGS:

Extending the Awning

- Insert the hook of the manual crank into the gear loop located on the left side of the awning.
- Turn the handle clockwise to extend the awning.
- Extend and attach the vertical support legs (refer to page 4).

Retracting the Awning

- Detach and stow the vertical support legs.
- Turn the handle counterclockwise to retract the awning.

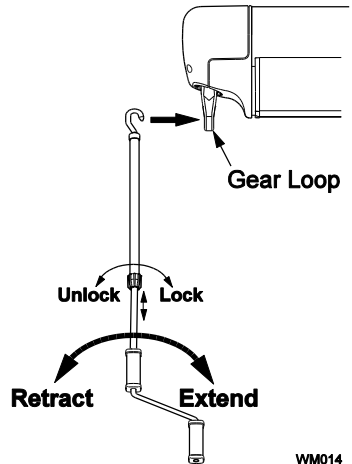

The crank handle may be extended or shortened by twisting the locking ring, then sliding the handle in or out to the desired length.

NOTICE Use care to not over extend the awning canopy. If the fabric begins to become slack, reverse the direction of the handle to tighten the fabric. Insure the fabric rolls onto the roller tube as shown. Rolling up the fabric in the wrong direction on the roller tube can damage the fabric and cause the awning to not operate correctly.

Special Note: This manual provides a basic description of the product and the standard operating controls provided by Carefree of Colorado. Some Original Equipment Manufacturers (OEM's) may alter or change the placement, style and/or functional configuration of the switches. If your controls do not match the style or description included, contact the coach manufacturer for an accurate description. OEM furnished components are not covered by the Carefree warranty.

VERTICAL SUPPORT LEGS

Two telescoping vertical support legs are stowed in the lead rail. These are used to provide increased stability and to adjust the height of the front edge (lead rail).

CAUTION The vertical support legs provide increased stability but do not compensate for harsh weather conditions such as wind and/or heavy rain. During inclement weather, retract and secure the awning in the travel position.

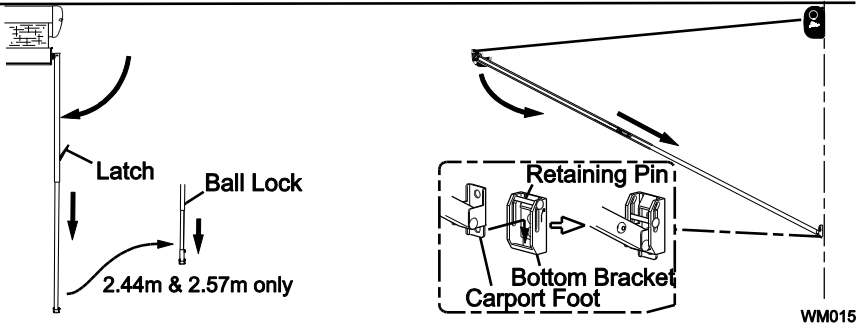
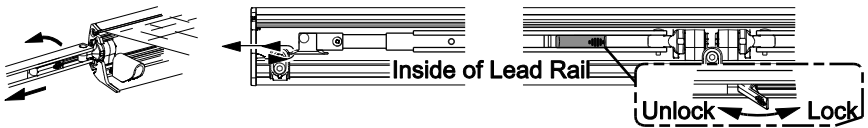

1. Extend the awning.
2. Unlock the latch on the leg then slide the foot back to clear the tabs on the lead rail endcap.
3. Lock the latch and slide the leg out the end of the lead rail until it stops. It will be necessary to lift the foot up to slide out of the end of the lead rail.
4. Horizontally rotate the leg 90 degrees.
5. Swivel the leg down.
6. *For 2.44m & 2.57m awnings:* Open the latch and extend the center section of the leg a minimum of 8" then pull the foot out until it locks in place with the ball lock.
7. *For Carport Position:*
 - Open the latch and extend the lower portion of the support down until the carport foot is touching the ground.
 - Hold the carport foot on the ground and lift the top section of the support until the awning is at the desired height. Close the latch.
 - Stake the carport foot to the ground. (Stakes are not included)
8. *For Wall Support:*
 - Open the latch then rotate and extend the leg to the bottom bracket.
 - Lift the retaining pin and insert the foot into the bracket. Allow the retaining pin to drop down over the foot.
 - Lift the top section of the support until the awning is at the desired height. Lock the latch.
9. Repeat for other side.

To stow the leg, reverse the above steps. See Caution on page 2.

AWNING CARE

Maintaining a Carefree Awning is easy. Just follow these basic steps:

- Always operate the awning according to the instructions.
- Periodically check that the fasteners are tight. Tighten if necessary.
- Keep the awning fabric and arms clean.

FABRIC CARE

NOTICE Do not use oil based cleaners or any caustic, granulated, or abrasive type cleaners on your Carefree product.

1. One of the best ways to keep the fabric looking good and to delay the need for deep or vigorous cleanings is to hose fabrics off on a monthly basis with clear water. This practice will help prevent dirt from becoming deeply imbedded in the fabric. In most environments, a thorough cleaning will be needed every two to three years.
2. When it's time for a thorough cleaning, the fabric can be cleaned while still on the awning frame.
 - For Vinyl Fabric – Use a soft brush and warm water with soap.
 - For Acrylic Fabric – Use a stiff brush and warm water with soap.
3. When cleaning the fabric, it is important to observe the following:
 - Always use a natural soap, never detergent.
 - Water should be cold to lukewarm, never more than 100°F.
 - Air-dry only. Never apply heat to the fabric.
 - Always allow the fabric to dry thoroughly before rolling up the awning.

MILDEW

Mildew is a fungus growth that looks like dirt. Vinyl coated polyester fabrics are mildew resistant because of a chemical biocide in the vinyl coating. Under ordinary conditions, mildew will not appear. However, in areas where high temperature and humidity are common, mildew can be a problem and require the material to be washed more frequently.

POOLING

When water collects on the top of the fabric, this is known as "pooling". This can occur during inclement weather or if a running air conditioner discharges over the awning. The water is dumped when the awning is retracted. It is recommended that if water accumulates; retract the awning in steps (8"-12") to dump the water. This will help prevent the fabric from stretching or distorting.

LEAKING

On vinyl canopies, side hems and poly cords are stitched in with a sewing machine. On occasion, this stitching may allow water to seep or leak through the stitches. This is normal and not a defect covered by warranty. Treat the seams with a quality seam sealer.

SUPPORT ARM CARE

The best method of keeping the support arms and braces operating smoothly is to clean them. Dirt and debris can cause the channels not to slide easily.

Periodically wash out the channels with running water (i.e. a hose) to keep them clean. If the channels still do not slide easily, lightly spray the joints and/or inside of the channels with a dry silicone lubricant after the arms have been cleaned and dried.

ARM NOISE

After a period of use, the arm knuckle joints may slide together slightly making a squeaking or squealing noise; this is normal and not a reason for concern. To reduce the sound, apply a few drops of multi-purpose oil (3-IN-1®¹ or equivalent) on the knuckle joint seams. Operate the awning and repeat 3-4 times to allow the oil to penetrate into the joint.

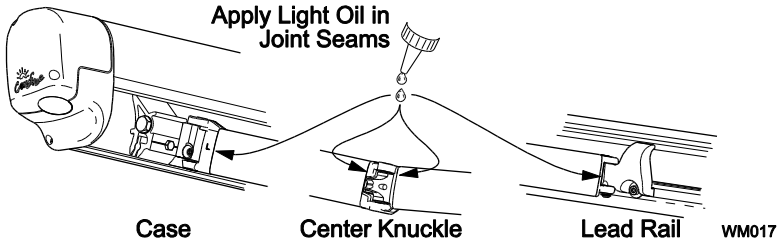

MANUAL OVERRIDE (MOTORIZED VERSIONS ONLY)

If power to the vehicle is not available, the awning can be safely retracted using the manual override located on the idler (right) end of the case.

NOTE: This procedure cannot be used to extend the awning.

1. Remove the plug from the right endcap and save.
2. Insert a 3/8" socket drive extension and handle into the square drive hole inside the endcap.
3. Turn the handle counterclockwise until the awning is retracted.
4. Replace the plug.

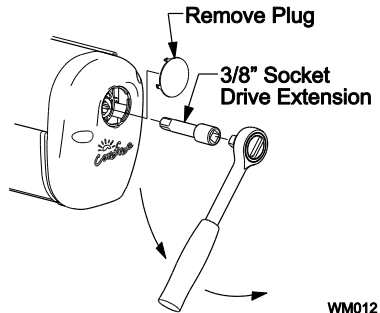

NOTICE After closing the awning with the manual override, the lead rail may move out from the case 1/4" -1/2". This is normal and the awning is secure for travel until power is restored or repairs are completed. Do not attempt to force the lead rail in with the override, serious damage can occur to the awning.

¹ 3-IN-1® is a registered trademark of the WD-40 company.

CAREFREE MAJOR PRODUCT LIMITED WARRANTY

Carefree of Colorado (hereafter referred to as Carefree) warrants to the first retail Purchaser that the Carefree Product is free of defects in material and workmanship within the terms and conditions as set forth in the warranty statement available online at www.carefreeofcolorado.com. Carefree's obligation under this warranty is limited to the repair or replacement, at Carefree's option, of any defective component with new or factory refurbished components.

OWNER MUST RETAIN THE ORIGINAL PROOF OF PURCHASE AND/OR HAVE THE PRODUCT WARRANTY REGISTRATION ON FILE AT CAREFREE FOR WARRANTY CLAIMS.

THIS WARRANTY IS NOT TRANSFERABLE.

Visit www.carefreeofcolorado.com for

- Warranty Duration;
- Warranty Coverage and Exclusions;
- Warranty Terms of Coverage; and,
- Warranty Claim Procedures

Register your Carefree products on-line at www.carefreeofcolorado.com

IMPORTANT NOTICE: It is strongly recommended that adjustments and repairs not described in this book be performed by trained technicians at your Authorized Carefree Dealer. Work performed by non-authorized persons or businesses may void warranty.

