

CAREFREE OMEGA AWNING

OWNER'S MANUAL/INSTALLATION INSTRUCTIONS

052888-0011 (AM)

CUSTOMER MUST RECEIVE THIS MANUAL UPON INSTALLATION—CONTAINS SECTIONS FOR SAFETY, INSTALLATION, OPERATION, CARE AND MAINTENANCE AND WARRANTY

IMPORTANT NOTE: READ ENTIRE INSTRUCTIONS BEFORE BEGINNING INSTALLATION. FOLLOW ALL CAUTIONS, WARNINGS AND NOTES TO PREVENT INJURY OR DAMAGE TO AWNING OR VEHICLE. IMPROPER INSTALLATIONS MAY RESULT IN BILLING. WARRANTY BENEFITS DO NOT APPLY TO IMPROPERLY INSTALLED OMEGA AWNINGS.

NOTE: WARNING LABELS MUST BE PUT INTO PLACE AS DESCRIBED IN STEP 7 BELOW! FAILURE TO DO THIS MAY RESULT IN DAMAGE TO AWNING OR RV!

TOOLS AND SUPPLIES REQUIRED

DRILL, 1/8" & 7/32" DRILL BITS, POP RIVET GUN
PUTTY TAPE OR SILICONE SEALER
1/4" & 5/16" SOCKET OR WRENCH

SECTION I: SAFETY INFORMATION

CAUTION: Means a hazard that may cause minor or moderate injury if the warning is ignored. It also may mean a hazard that will cause damage to property.

CAUTION: RAIL MUST BE MOUNTED SUCH THAT IT DOES NOT INTERFERE WITH THE SLIDEOUT CLOSING AND SEALING WHEN IT IS IN THE COMPLETE RETRACTED POSITION.

CAUTION: THE COTTER PINS ARE HOLDING THE PRE-WOUND TENSION ON THE ROLLER ASSEMBLY. CARE MUST BE TAKEN TO PREVENT ANY DAMAGE OR INJURY WHEN REMOVING THESE PINS.

CAUTION: DO NOT RELEASE STRAP UNTIL THE AWNING IS AGAINST THE SLIDEOUT FACE. THIS SPRING RETURN WILL RAPIDLY ROLL UP AWNING RESULTING IN A SLAM AGAINST THE SLIDEOUT FACE, POSSIBLY DAMAGING THE RV OR AWNING!

WARNING: FAILURE TO PUSH THE LOCK UP TO THE UNLOCKED POSITION PRIOR TO EXTENDING THE SLIDEOUT ROOM WILL RESULT IN DAMAGE TO THE AWNING AND THE RV!

WARNING: ROLLER LOCK MUST BE ENGAGED PRIOR TO TRAVEL! FAILURE TO DO THIS COULD RESULT IN BILLING AND DAMAGE TO THE AWNING AN THE RV WHICH WILL NOT BE COVERED BY WARRANTY!

SECTION II: SPECIFICATIONS

IMPORTANT NOTE: BEFORE BEGINNING THE INSTALLATION, BE SURE TO READ THE INFORMATION BELOW TO ENSURE THAT THE OMEGA AWNING IS THE CORRECT SIZE!

- Omega Awnings are custom made for the length and extension of the slideout room. The actual canopy of the Omega Awning will measure approximately 4" longer than the "B" dimension on the order form.
- Arm mounting brackets must mount on a flat surface that is a minimum of 1-1/6" wide.

SECTION III: OMEGA INSTALLATION

1. INSTALLING AWNING RAIL:

- Remove rail from shipping tube. Apply sealer (putty tape or silicone) to the back surface of the rail.
- Determine the exact location the rail is to be mounted by following the guidelines listed below.
 - Rail can be mounted with the slot (where fabric slides in) facing up or with the slot facing down for **non-alumaguard (non-metal wrap) awnings**.
For alumaguard (metal wrap) awnings, the rail must be mounted with the slot facing upward.
 - Rail must mount on to a straight, flat, solid mounting surface.
 - Whenever possible, rail should be mounted 4" above the face of the slideout room to prevent any possibility of binding, etc.
 - Rail must be mounted to where the slot of the rail is positioned a **minimum** of 1" above the face of the slideout for non-alumaguard awnings and 2-1/2" above the face of the slideout for alumaguard awnings.

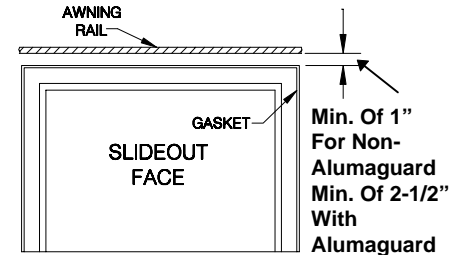

CAUTION: RAIL MUST BE MOUNTED SUCH

THAT IT DOES NOT INTERFERE WITH THE SLIDEOUT CLOSING AND SEALING WHEN IT IS IN THE COMPLETE RETRACTED POSITION.

Whenever possible, mount the rail 4" to 6" above the face of the slideout to achieve more pitch. However if mounting at that height, the support behind the skin of the vehicle may be minimal. **If this is the case, it will then be necessary to ensure the rail is mounted solid enough by using molly rivets (not supplied) through the areas where there is only skin and attaching the rail with supplied screws at various vertical support beams.**

2. HANGING OF OMEGA AWNING

- Remove tape from roller assembly and unwrap (1) wrap of material to allow for easy insertion into awning rail.
- Slide entire Omega roller assembly into awning rail and center over slideout. Fasten canopy to rail with a #6 Hex head screw at each end of the rail.

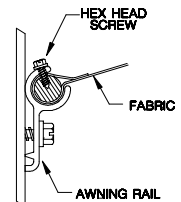

3. MOUNTING LEFT ARM ASSEMBLY

- Make sure Omega awning is centered over slideout. This should place each mounting bracket edge at the outer most mounting point, still inside of any rubber gasket or trim that may be attached to the edge of the slideout.
- Slide the roller lock assembly over the left tubular arm. Insert arm assembly into roller tube. Position the roller lock assembly on the straight section of the arm and align it with the roller sprocket.

3. MOUNTING LEFT ARM ASSEMBLY (cont.)

- C. Align the left arm vertically with the slideout face. For Omegas without alumaguard position the center of the top hole of the arm bracket 10" below the slot of the awning rail. For acrylics with alumaguard position the center of the top hole in the arm bracket 8-1/2" below the slot of the awning rail.

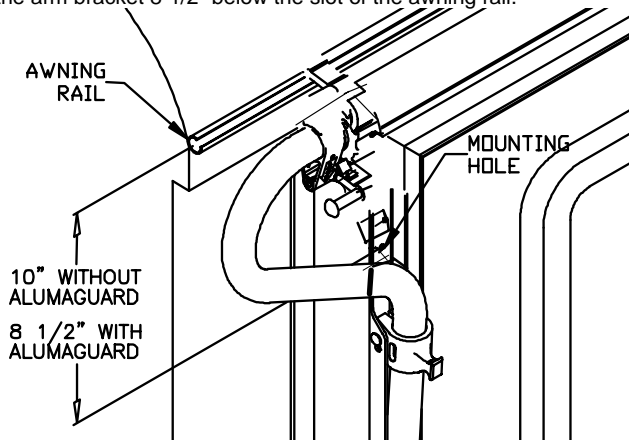

- D. Using either a #10 x 3/4" Hex head screws or a 3/16" pop rivet, attach the arm bracket to the slideout face. Pop rivets are preferred when mounting the brackets on the slideout flange. **NOTE: WHEN MOUNTING BRACKETS, TAKE CARE THAT THE FASTENERS DO NOT PENETRATE OR INTERFERE WITH ANY RUBBER SEAL ON THE SLIDEOUT EDGE.**
- E. Make sure room is retracted completely. Position the roller lock assembly by pushing the manual lock lever up to the unlocked position and align it with the roller sprocket
- F. Place the manual lock in the Locked position and rotate it until it engages in a slot in the sprocket. **ATTACH THE ROLLER BRACKET AT THIS POINT TO THE TUBULAR ARM BY INSTALLING A #10 X 3/4" HEX HEAD TEK SCREW THROUGH THE HOLE IN THE ROLLER BRACKET AND INTO THE TUBULAR ARM.**
- G. **NOTE: IF THE EXTRUDED POINT OF THE MANUAL LOCK LEVER FALLS ON A HIGH SIDE OF THE SPROCKET WHEN THE ROOM AND AWNING ARE COMPLETELY RETRACTED IT WILL STILL FUNCTION PROPERLY. IF THE ROLLER STARTS TO TURN IT WILL AUTOMATICALLY ENGAGE IN THE NEXT SLOT ON THE SPROCKET.**

NOTE: VERIFY THAT THE MANUAL LOCK LEVER OPERATES FREELY AND DOES NOT HAVE ANY INTERFERENCE WITH THE SLIDEOUT FACE OR THE BODY OF THE COACH.

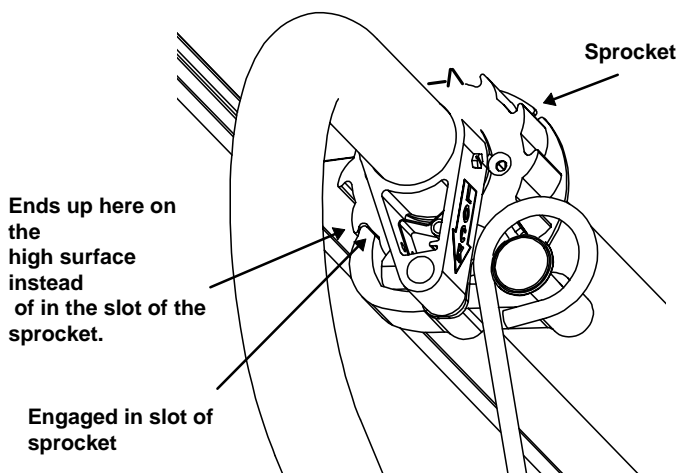

4. MOUNTING RIGHT ARM ASSEMBLY

- A. Engage the pin inside of the right arm assembly into the spring adapter. (spring adapter is sticking out of the end of the roller tube. Rotate 45 degrees counter clockwise looking down the roller from the right side. **PULL THE COTTER PIN OUT. CAUTION: THE COTTER PIN IS HOLDING THE PRE-WOUND TENSION ON THE ROLLER ASSEMBLY. CARE MUST BE TAKEN TO PREVENT ANY DAMAGE OR INJURY WHEN REMOVING THIS PIN.** Push the arm into the roller tube.

- B. Align the right arm vertically with the slideout face. **Position the center of the top hole of the arm bracket 10" below the slot of the awning rail for non alumaguard awnings and 8-1/2" below the slot in the rail for acrylic with alumaguard.** Using either a #10 x 3/4" Hex head screw or a 3/16" pop rivet, attach arm bracket to the slide out face through the top hole of the bracket. Repeat with bottom hole. Pop rivets are preferred when mounting the brackets on the slideout flange. **NOTE: WHEN MOUNTING BRACKETS, TAKE CARE THAT THE FASTENERS DO NOT PENETRATE OR INTERFERE WITH ANY RUBBER SEAL ON THE SLIDEOUT EDGE.**

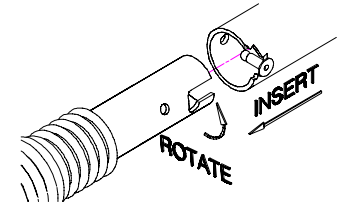

5. INSTALLING PULL STRAP CATCHES

- A. Push the locking lever up until you hear a click. This will be the unlocked position. (See Operating Instructions) Extend room completely out. Be alert to roller latches stopping the room.
- B. Grasp the pull cane and push the arm locks up to the unlocked position. Again with the pull cane, grasp the center pull strap and extend the awning into the window awning position.
- C. Insert one pull strap catch into the loop of the center strap.
- D. Position the strap vertically under proper tension, mark the mounting hole locations for the strap catch. **NOTE: ARMS SHOULD BE POSITIONED SUCH THAT THEY ARE AS CLOSE TO BEING PERPENEDICULAR WITH THE SIDEWALL OF THE SLIDEOUT AS POSSIBLE.**
- E. Drill 1/8" or 7/32" holes into the slideout face and attach catch with either #10 x 3/4" screws or 3/16" molly rivets as needed.
- F. With the awning rolled out and hooked to the center pull strap catch, repeat the steps above with the two outer pull straps approximately 12" in from the arm channel. To ensure proper function and appearance, these straps should be positioned such that they are vertically aligned and tight to match the center strap.

6. SECURING THE OMEGA AWNING

- A. Extend and retract slideout a few times to verify the awning is centered and rolling up straight.
- B. If necessary, shift fabric one way or another by removing the previously installed screws in the awning rail and adjusting fabric accordingly.

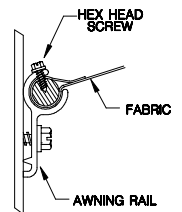

7. ATTACHING WARNING LABELS

PEEL THE PAPER OFF OF THE BACK OF THE TWO THIN RED WARNING LABELS AND ADHERE THE WARNING LABELS WHERE THEY WILL BE IN PLAIN SIGHT NEXT TO THE SLIDEOUT OPERATING SWITCH OR ON THE SLIDEOUT SAFETY JACK OR THE ROOM TRAVEL LOCK BRACE. PLACE THE THICKER RED LABEL OVER THE OPERATING SWITCH AS DESCRIBED IN THE ATTACHED COLORED SHEET OF PAPER. THESE LABELS MUST BE PUT INTO PLACE TO ENSURE THE CUSTOMER KNOWS TO LOCK THE MANUAL LOCK FOR TRAVEL AND UNLOCK IT BEFORE EXTENDING ROOM! FAILURE TO DO THIS COULD RESULT IN DAMAGE TO BOTH THE AWNING AND THE RV!

8. INSTALLATION QUALITY CHECK LIST

REVIEW THE FOLLOWING QUALITY CHECK LIST TO ENSURE A PROPER INSTALLATION.

1. PROPER ARM LOCATION CHECK

- FOR ALUMAGUARD AWNINGS: The arm bracket top mounting hole must be positioned 8-1/2" below the bead of the awning rail.
- FOR NON-ALUMAGUARD AWNINGS: The arm bracket top mounting hole must be positioned 10" below the bead of the awning rail.

2. MANUAL LOCK CHECK

- Verify that the Manual Lock operates freely and does not have any interference with the slideout face or the body of the coach.
- Verify that the Manual Lock extruded hook is in line with the Roller Sprocket
- Verify that the Manual Lock is installed on the left hand tubular arm looking at it as you face the slideout.

Installation must comply with all items on the check list.

Improper installations may result in billowing or binding.

Warranty benefits do not apply to improperly installed Omega Awnings.

SECTION IV: OPERATING INSTRUCTIONS

1. TO EXTEND OMEGA AWNING

- A. Grasp pull cane and push the red locking lever on the roller lock up to the unlocked position. **WARNING: FAILURE TO PUSH THE LOCK UP TO THE UNLOCKED POSITION PRIOR TO EXTENDING THE SLIDEOUT ROOM WILL RESULT IN DAMAGE TO THE AWNING AND THE RV!**

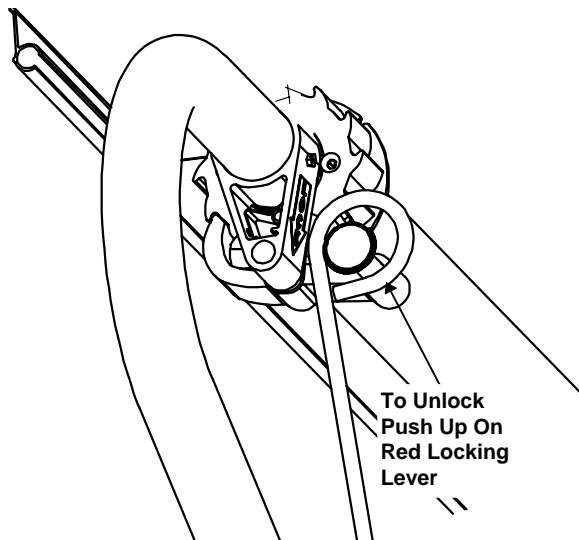

- B. Extend slideout to its full extension.
- C. The Omega awning will automatically unroll attaining full coverage when slideout achieves maximum extension.
NOTE: ROOM MUST EXTEND STRAIGHT (EQUAL AT BOTH ENDS) IN ORDER FOR THE FABRIC TO TIGHTEN UP UPON FULL EXTENSION!
- D. Grasp pull cane and push arm lock up to the unlocked position.
- E. Grasp or hook center pull strap loop and unroll the awning and hook the loops of the other pull straps onto the pull strap catches.
NOTE: WATER MAY POOL ON TOP OF THE EXTENDED OMEGA. THE WATER WILL BE DUMPED AUTOMATICALLY AS THE SLIDEOUT IS RETRACTED.

2. TO RETRACT OMEGA AWNING

- A. Remove loops of pull straps from catches and grasp center pull strap allowing awning to roll up to its stored position against the slideout face. Use the pull cane to assist in this. **CAUTION: DO NOT RELEASE STRAP UNTIL THE AWNING IS AGAINST THE SLIDEOUT FACE. THIS SPRING RETURN WILL RAPIDLY ROLL UP AWNING RESULTING IN A SLAM AGAINST THE SLIDEOUT FACE, POSSIBLY DAMAGING THE RV OR AWNING!**
- B. Grasp pull cane and pull arm lock down to the locked position.
- C. Retract slideout to the complete closed position.
NOTE: WHEN RETRACTING SLIDEOUT IT IS A GOOD IDEA TO STOP THE ROOM HALFWAY IN AND ENSURE FABRIC IS ROLLING PROPERLY BEFORE CONTINUING RETRACTION.
- D. Once the room is retracted, grasp the pull cane and pull down on the red locking lever of the roller lock until you hear a click. This will then be in the fully locked position. **WARNING: ROLLER LOCK MUST BE ENGAGED PRIOR TO TRAVEL! FAILURE TO DO THIS COULD RESULT IN BILLOWING AND DAMAGE TO THE AWNING AN THE RV WHICH WILL NOT BE COVERED BY WARRANTY!**

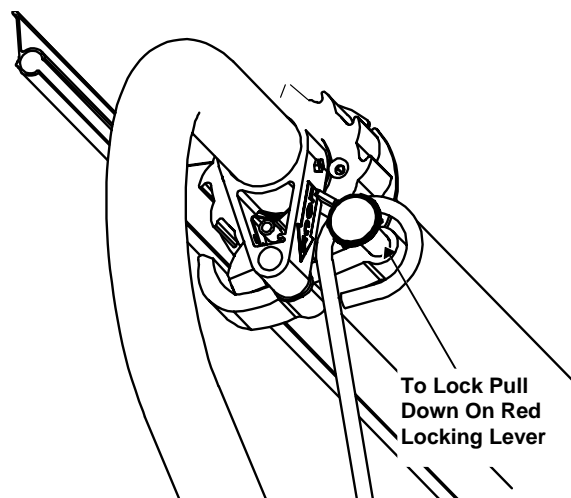

SECTION V: CARE AND MAINTENANCE

CLEANING: VINYL

Mildew will not form on the awning material itself, but may form on the dust allowed to accumulate on the canopy. A quality vinyl cleaner such as Carefree Awning Magic will keep your awning looking new. Once cleaned make sure the awning is rinsed thoroughly and is dried before storing. **DO NOT USE BLEACH!**

CLEANING: ACRYLIC

Carefree Awning Magic should be used to clean the acrylic canopy. A stiff brush may be necessary to help when removing tough stains. Once cleaned, use plenty of clean water to completely rinse fabric clean. **CAUTION: DO NOT USE CAUSTIC CLEANERS, MILDEW REMOVERS OR METAL CLEANERS ON FABRIC AS THEY CAN DESTROY COLORS AND WILL NOT BE COVERED BY WARRANTY.** Metal surfaces should be cleaned with a warm soapy solution and thoroughly rinsed. **NOTE: ALLOW CANOPY TO DRY COMPLETELY BEFORE ROLLING AWNING UP.**

WATER POOLING

UNDER CERTAIN CONDITIONS, WATER MAY POOL ON THE TOP OF THE EXTENDED OMEGA. IF WATER IS ALLOWED TO POOL ON THE FABRIC FOR A LONG PERIOD OF TIME, IT MAY CAUSE THE FABRIC TO STRETCH. THIS IS NOT COVERED UNDER WARRANTY! TO PREVENT THE FABRIC FROM STRETCHING IF SUBJECTED TO WATER POOLING, PERIODICALLY RETRACTTHE ROOM THUS ALLOWING THE WATER TO AUTOMATICALLY DUMP OFF OF THE FABRIC AS THE ROOM GOES IN.

Periodically check all fasteners to make sure they remain tight.

SECTION VI: WARRANTY

1. **Duration:** Two & Four Year Limited warranty. Two years parts labor and freight on canopy, four years parts labor and freight on springs, roller, and hardware.
2. **Who gives this warranty?**
Carefree of Colorado, A Scott Fetzer Company (the "Company").
3. **Who receives this warranty?**
The original purchaser (the "purchaser") other than for purposes of resale, of an Omega awning. This warranty is not transferable.
4. **Responsibilities of the Company under this warranty?**
Repair or replace at Warrantor's option, of the covered part (parts) which Warrantor, in the exercise of its reasonable discretion, determines to be effective; provided that the Warrantor receives notice of the defect within the stated warranty period for the respective servicing dealer or agent for performing any repairs he respective product / component. Warrantor will also pay the authorized by Warrantor as per the terms of this warranty.
Company will allow for freight and labor charges - labor is based on Flat Rate Form. CHARGES FOR TRAVEL TIME AND MILEAGE ARE NOT COVERED BY THE WARRANTY.
5. **Responsibilities of the Purchaser under this warranty.**
 - A. Promptly notify seller, or alternately, the Company of any claim hereunder.
 - B. Retain dated proof of purchase for specified product and provide it as requested
 - C. Inspect the awning upon purchase to confirm the condition of the canopy and the proper operation of the product.
 - D. Perform "Periodic Preventative Maintenance" as specified in Owners Manual.
 - E. Deliver any product claimed or found defective during warranty period to the nearest Carefree of Colorado Authorized Service Dealer. The Original Purchaser is responsible for any expenses related to delivery or pick up of product to / from the Service Dealer. Visit carefreeofcolorado.com for the name of the nearest Authorized Service Dealer, or call Carefree at the number shown above.
 - F. At the option the Company return the product or part to Carefree of Colorado for inspection. Carefree Authorization to Return form must be obtained before any product or part is returned.
 - G. Use reasonable care in maintenance, operation, use and storage of the product in accordance with the instructions contained in the owner's manual.
6. **What is covered by warranty?**
 - A. Defect's on the manufacturers material and workmanship of product under normal use, and which occur within the duration of the warranty period. On all awnings, the following parts are covered only as follows: (a) Fabrics, free from quality defects (normal wear and fading are excluded); (b) Roller Tube, against extrusion defects; (c) Springs (or motor) Assembly(ies), against breakage; and (d) Hardware, against extrusion defects.
 - B. Omega Awning Roller Tube – 4 Year Limited Warranty
Omega Awning springs are warranted not to break for four years. THIS DOES NOT INCLUDE HIGH WINDS OR WATER POOLING ON THE CANOPY.
 - C. Omega Awning Spring Assembly – 4 Year limited Warranty
Omega Awning Springs are warranted not to break or pull loose if not over-wound or subjected to high winds or water pooling on the canopy.
 - D. Omega Awning Canopy – 2 Year Limited Warranty
Omega Awning Canopy material is warranted against:
 - 1) Excessive fading (there is always slight color change due to ultraviolet rays):
 - 2) Mildew (however, mildew will form on dirt which has not been removed):
 - 3) Cracking, peeling, hardening, sagging or loss of strength if not subjected to high winds or water pooling on the canopy.
7. **What is not covered under this warranty?**
 - A. Fabric damage such as pinholes or tears not reported within ten (10) calendar days of purchase.
 - B. Improper installation and / or any damage or failure that results from improper installation of the product, including fabric damage caused by improper installation.
 - C. Product abuse and normal wear. "Normal Wear" includes the occasional need to re-tension the awning.
 - D. Conditions that are not related to the materials or workmanship of the product:: including any failure the results from an accident, wind, rain, water pooling, or other acts of God; purchaser's abuse; neglect; failure to operate, or use or maintain the product in accordance with the instructions provided in the Owner's Manual supplied with the product; (failure to operate the product(s) in accordance with instructions in the Owner's Manual and on the product shall also include the removal or alteration of any product component or device. In the event of any such removal or alteration , this warranty is void).
 - E. Any component not sold or manufactured by the Company.
 - F. ANY INCIDENTAL, INDERECT, OR CONSEQUENTIAL LOSS, DAMAGE, OR EXPENSE THAT MAY RESULT FROM ANY DEFECT, FAILURE , OR MALFUNCTION OF THR CAREFREE OF COLORADO PRODUCT. Some states do not allow the exclusion or limitation or exclusion may not apply to you.
 - G. Damage while traveling due to the awning not properly stowed.
 - H. Any failure that results from the use of another product with a Warrantor's product that is not specifically approved by the Warrantor.
8. **When Warrantor will perform repair or replacement under warranty.**
 - A. Repair or replacement will be scheduled and performed according to normal work flow at the nearest Authorized Service Dealer, and depending on the availability of replacement parts.
 - B. If the Purchaser does not receive satisfactory results from the Authorized Service Dealer, the Purchaser should contact the Carefree of Colorado Customer Care Department.

THIS WARRANTY GIVES YOU THE SPECIFIC LEGAL RIGHTS AND YOU MAY ALSO HAVE OTHER RIGHTS WHICH VARY FROM STATE TO STATE. No action to enforce this warranty shall be commenced later than 30 days expiration of the warranty period. The duration of this Limited Warranty also limits the duration of any implied warranty such as warranty of merchantability or fitness for a particular use or purpose . Some states do not allow such limitations so the implied warranty limitation may not apply to you. Carefree of Colorado reserves the right to change the specifications and design of any product without notice and with no obligation to make corresponding changes to products previously manufactured.

**Carefree
of Colorado**

A Scott Fetzer Company
2145 W. 6th Ave.
Broomfield, Co. 80020
(303) 469-3324