



# SERVICE MANUAL PARAMOUNT

## RV

### 2-Stage Multi-Position Awning



Read this manual before servicing this product. Failure to follow the instructions and safety precautions in this manual can result in personal injury and/or cause the product to not operate properly.

For LED replacement parts and service procedures refer to 070013-301 “LED Service Manual for Box Awnings” available on-line at [www.carefreeofcolorado.com](http://www.carefreeofcolorado.com)

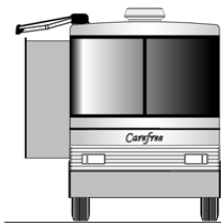

Slide-Out Position

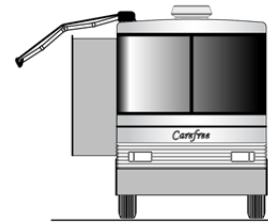

Window Position

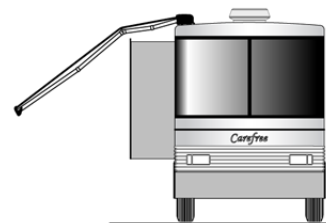

Patio Position

## PROPRIETARY STATEMENT

The Paramount Awning is a product of Carefree of Colorado, located in Broomfield, Colorado, USA. The information contained in or disclosed in this document is considered proprietary to Carefree of Colorado. Every effort has been made to ensure that the information presented in the document is accurate and complete. However, Carefree of Colorado assumes no liability for errors or for any damages that result from the use of this document.

The information contained in this manual pertains to the current configuration of the models listed on the title page. Earlier model configurations may differ from the information given. Carefree of Colorado reserves the right to cancel, change, alter or add any parts and assemblies, described in this manual, without prior notice.

Carefree of Colorado agrees to allow the reproduction of this document for use with Carefree of Colorado products only. Any other reproduction or translation of this document in whole or part is strictly prohibited without prior written approval from Carefree of Colorado.

## SAFETY INFORMATION



**This is the safety alert symbol. It is used to alert individuals to potential personal injury hazards. Obey all safety messages that follow this symbol to avoid possible personal injury or death.**



Indicates a hazardous situation, which if not avoided, could result in death or serious bodily injury.



Indicates a hazardous situation, which if not avoided, may result in minor or moderate bodily injury.



Indicates a situation that may result in equipment-related damage.

### General Safety:



**This product can expose you to chemicals including Di-isodecyl phthalate (DIDP), Vinyl Chloride and Formaldehyde, which are known to the state of California to cause cancer or birth defects or other reproductive harm. For more information visit [www.P65warnings.ca.gov](http://www.P65warnings.ca.gov)**



**Shock Hazard. Always disconnect battery or power source before working on or around the electrical system.**



**Always wear appropriate safety equipment (i.e. goggles).**



**Always use appropriate lifting devices and/or helpers when lifting or holding heavy objects.**



**When using fasteners, do not over tighten. Soft materials such as fiberglass and aluminum can be "stripped out" and lose the ability to grip and hold.**

Electric components in this product have been tested by the following agencies:



**Motor:** UL Recognized (USA)  
CSA Approved (Canada)

**Controls:** UL Listed (USA & Canada)



# TABLE OF CONTENTS

- Product Overview ..... 2**
  - Paramount Patio Awning Specifications .....2
- Standard System Adjustments ..... 3**
  - Setting the Motor Limits .....3
  - OUT Limit Switch .....3
  - IN Limit Switch .....3
  - Awning Calibration Procedure .....4
  - Procedure.....4
  - Adjusting the Lead Rail.....6
  - Adjusting the Lead Rail Height.....6
  - Adjusting the Horizontal Lead Rail Position .....6
  - Manual Override .....7
  - Programming the RF Receiver for a Remote .....8
  - Standard Maintenance.....9
  - Fabric Care .....9
  - Mildew .....9
  - Pooling .....9
  - Arm Care.....9
  - Arm Noise .....9
- Canopy Replacement ..... 10**
- Motor Replacement ..... 11**
  - Modifying the Top Cover.....13
- Short Spring Arm Replacement ..... 14**
  - Removing the Existing Arm.....14
  - Installing the New Arm .....15
- Long Spring Arm Replacement..... 16**
  - Removing the Existing Arm.....16
  - Installing the New Arm .....16
- Removing the Awning..... 17**
- Diagnostic Tests..... 18**
  - Common Operation Items.....18
  - Testing the System .....19
- Electronics ..... 23**
  - Wiring Diagram – Single Awning .....23
  - Wiring Diagram – 2-Awnings .....24
  - Phone Cord Connection.....25
  - Wiring Diagram – 4 Awnings .....26
  - Connection Flex w/ "110VDR" Control Boxes .....28
  - Optional Manual Bypass Switch .....28
  - Sensor Replacement .....29
- Part Number Listing ..... 30**
  - Serial Number/Part Number Location.....30
  - Illustrated Parts List .....30
  - Electronic Components .....32

## PRODUCT OVERVIEW

The Paramount Patio Awning offers the coach owner an awning system that provides as much or as little shade as required. The canopy is housed in an aluminum case that easily blends in with the coach roof.

Each unit is equipped with lateral support arms that are the strongest available on the market. No vertical arms interfere with coach sidewalls or equipment that may be mounted on the roof.

The unique and innovative 110V electronic control system provides Carefree's *Direct Response* system with interior pushbutton controls for standard extend/retract functions. At the master control panel the auto-retract system can be engaged to automatically retract the awning in windy conditions. Sensitivity can be set to respond to a variety of wind speed conditions. An RF remote is furnished with the *Direct Response* system.

### Paramount Patio Awning Specifications

The following information is for reference only.

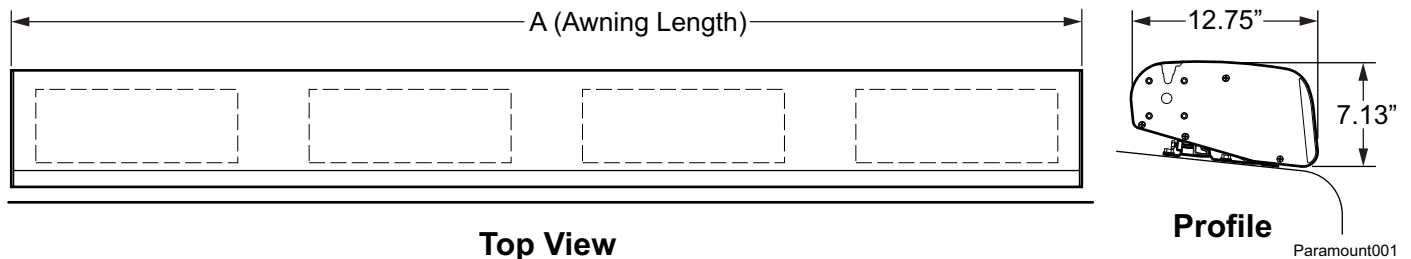

<b>LENGTH</b>	14' – 21' (in 1 foot increments)			
Position:	Slide-Out	Window	Patio	
<b>EXTENSION:</b>	40"	72"	106"	
<b>LEAD RAIL DROP</b>	6" (20°)	32" (33°)	51" (33°)	
<i>Values are approximate, actual dimensions may vary with specific installations. Angles are measured from horizontal (parallel to ground)</i>				

<b>MOTOR SPECIFICATIONS:</b>		Available in LH or RH configurations	
Type:	Tubular Motor		
Power:	120V, 60HZ, 2.5A		
Torque:	60 nm		
Speed:	14 RPM		
Cycle:	40 Sec ON / 1 Min OFF		
<b>CONTROLS:</b>	Direct Response Electronics with a single master control and single remote for all awnings.		
<b>COLOR:</b>	Hardware:	White, Black	
	Fabric:	Woven Acrylic Fabric	

<b>APPROXIMATE INSTALLED WEIGHT (LBS.)</b>					
Awning Length (ft.)	Weight	Awning Length (ft.)	Weight	Awning Length (ft.)	Weight
14	195	17	227	20	258
15	212	18	234	21	266
16	220	19	246		

Optional factory installed 12V LED lighting is available for the Paramount awning. LED lighting requires a separate 12V control switch.

There are two configurations of the Paramount based on the canopy construction as shown.

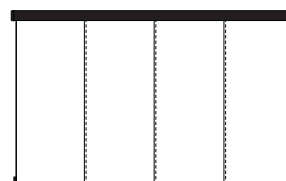

**VS Configuration**  
Canopy construction with vertical seams



**HS Configuration**  
Canopy construction with horizontal seams

Mirage056

## STANDARD SYSTEM ADJUSTMENTS

### SETTING THE MOTOR LIMITS

The "OUT" limit switch is used to stop the motor when the awning is fully extended. The "IN" limit is NOT USED with the *Direct Response* system (see description below).

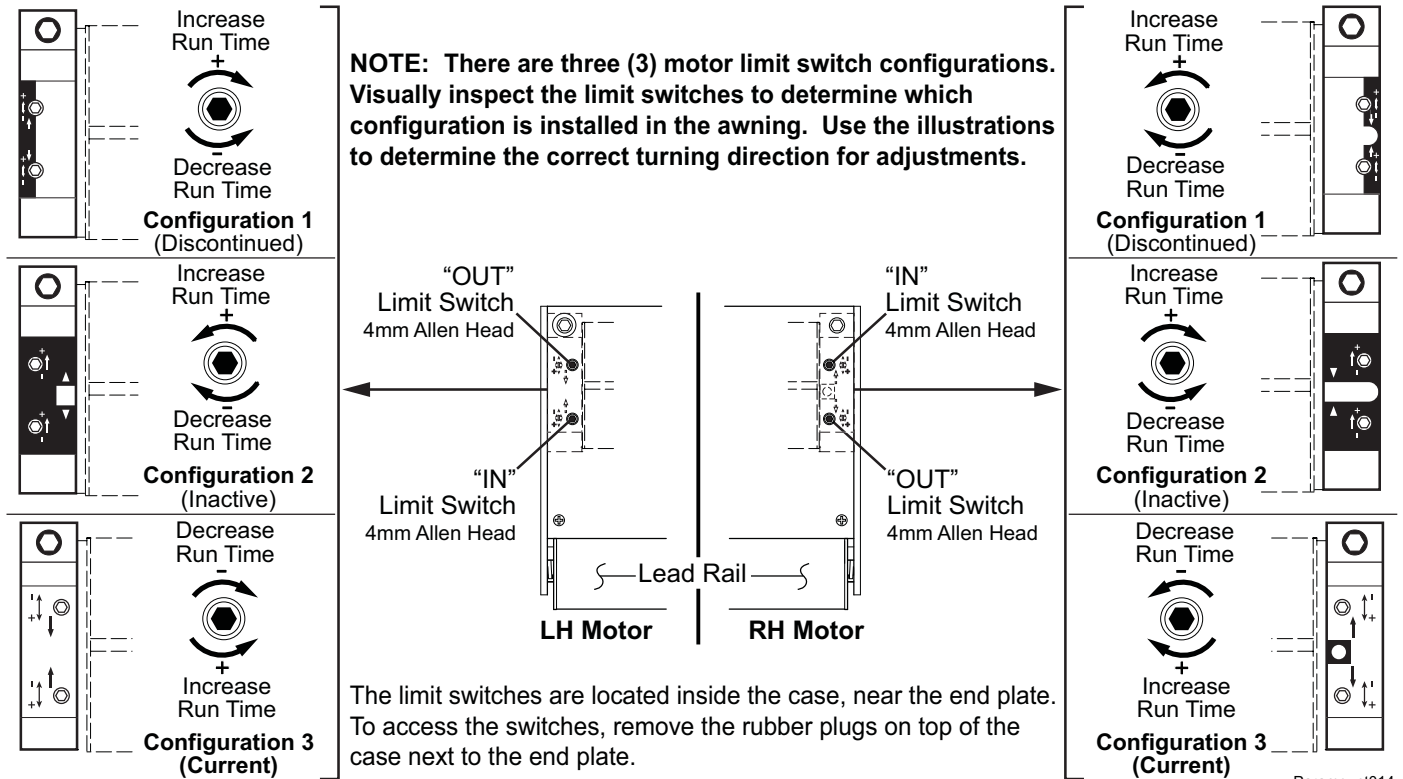

#### OUT Limit Switch

1. Extend the awning out completely.
2. Confirm that the arms are fully extended. The motor should stop and the fabric should be tight. If the motor continues to run, the fabric will sag; or, if the motor quits before the arms are fully extended, it will be necessary to adjust the "OUT" limit switch.
 

**NOTE:** It is best to make the adjustments in increments of a single turn. 3 full turns of the screw equals approximately 2" of fabric extension.
3. If the fabric sags:
  - 3.1. Retract the awning until the fabric is tight then retract an addition 10"-12".
  - 3.2. Using a 4mm Allen wrench turn the "OUT" limit switch to reduce the time the motor runs.
  - 3.3. Extend to confirm that the adjustment is correct.
  - 3.4. Repeat the procedure until the awning extends correctly.
4. If the arms do not extend completely:
  - 4.1. Retract the awning approximately 10"-12".
  - 4.2. Using a 4mm Allen wrench turn the "OUT" limit switch to increase the time the motor runs.
  - 4.3. Extend to confirm that the adjustment is correct.
  - 4.4. Repeat the procedure until the awning extends correctly.

#### IN Limit Switch

**NOTE:** The "IN" limit switch is not adjusted with the *Direct Response* system. The system electronics monitors the motor and shuts the motor off when the awning is fully retracted.

If the IN limit switch is accidentally adjusted, the motor may shut off before the awning is fully closed. If this occurs, turn the "IN" adjustment screw to INCREASE the motor run time. It is not necessary that the screw matches the closed position.

**NOTE:** It is normal for the lead rail to slightly relax after the awning closes completely.

## AWNING CALIBRATION PROCEDURE

If the awnings do not align at the intermediate positions (slide-out and window), it is necessary to run a calibration routine to adjust the run and stop times for the awning.

1. The controls are programmed with default awning calibration values; this allows full awning operation out-of-the-box.
2. The default calibration values are based on the average run times for the Paramount awning; these values are close but not perfect.
3. The Slide-Out Cover and Window awning intermediate positions are set as a percentage of the awning run time, 29% for Slide-Out Cover and 70% for Window.
4. Performing an awning calibration collects the actual extend and retract run times to allow the most accurate awning operation.
5. For multiple awning installations, adjacent awnings must be aligned in the full extension position before initiating awning calibrations, otherwise, a calibration will lock-in the difference in run times and will cause misalignment at the intermediate positions.
6. For multiple awning installations, it is recommended that all awnings be calibrated at the same time while operating on the same power source, i.e. do not calibrate one awning while operating on the inverter and another while operating on the generator.
7. If a calibration is started and fails (stops) for any reason, the system resets the travel time and maximum run time to the default values.

### *Procedure*

Prior to starting the procedure, ensure that the motor limits are set correctly (refer to page 3).

- The IN limit switch must be set to allow the motor to stall. Calibration will fail if the switch is set to stop the motor.
- The OUT limit switch is used to align adjacent awnings in the fully extended position before initiating awning calibrations, otherwise, a calibration will lock-in the difference in run times and will cause misalignment at the intermediate positions.

**NOTICE** Do not continuously operate the awning more than 2-3 cycles maximum. The motor is equipped with a thermal protection circuit to protect the motor from overheating. Operating the awning repeatedly over a short time period may cause the circuit to sense an overheat condition and shut off the motor. If this occurs, wait approximately 15 minutes to allow the motor to cool then resume the procedure.

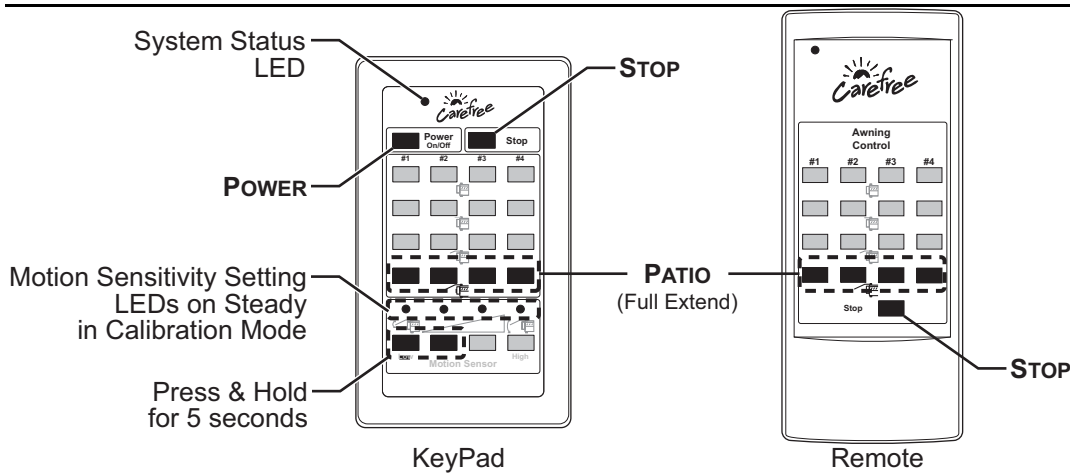

Paramount012

**NOTE:** 4-awning keypad and remote shown. Description and procedures apply to all configurations.

1. Ensure that power is available to the awning control system.
2. Turn the system power on at the keypad.
3. To initiate calibration mode: At the keypad, Press and Hold the two lower value buttons of the sensitivity settings for a full 5 seconds.
  - When the system is in calibration mode, the system status LED will flash and the four (4) sensitivity setting LEDs will illuminate as steady ON.
  - The system will remain in calibration mode for 30 seconds. If an awning is in the calibration cycle when the 30 second window expires, the awning will complete the calibration.
  - In calibration mode, all functions except for the "Patio" and "Stop" commands are disabled.
  - If the "Stop" button is pressed during a calibration, all awning calibrations are halted immediately and the system returns to normal operation. The calibration mode must be reinitialized to continue. Any awnings that were stopped partially through a calibration will be reset to the default values.
  - In calibration mode, any or all awnings can be calibrated and/or re-calibrated.
4. At the keypad or on the remote, press and release the "Patio" button to start the calibration for the selected awning.
  - The awning will partially extend then retract to determine the full retract position. Next, the awning will cycle to the full extend (patio position) then retract to the fully closed position. When the awning has returned to the fully retracted position, the individual awning calibration is complete. Repeat for each awning installed.
  - For multiple awning installations, it is not necessary to wait for one awning to complete the calibration cycle before starting the next awning calibration.
  - In calibration mode, pressing the "Patio" button for an awning that has been calibrated will cause the awning to recalibrate.

## ADJUSTING THE LEAD RAIL

### *Adjusting the Lead Rail Height*

The Paramount arms are installed and adjusted at the factory to operate at the tallest height possible. For multiple awning installations, the lead rails of adjacent awnings may appear to not align because of installation variables. The height of the high lead rail may be lowered with the procedure below. This is not a pitch adjustment. Maximum height adjustment is approximately 6 3/8".

1. Fully extend the awnings.
2. On the middle rail, locate the long arm knuckle closest to the adjacent awning.
3. Loosen the securing screws located on the outside of the knuckle. DO NOT remove these screws.
4. Turn the adjustment screw counter clockwise to lower the lead rail. Turn the screw in increments of 1/2 turn until the lead rail matches the adjacent awning lead rail.

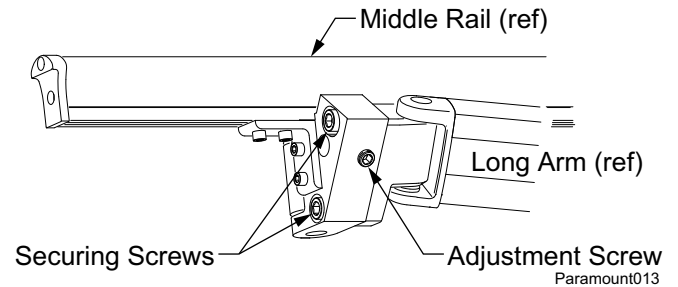

*Tip: If the screw is hard to turn, have a second person lift up on the lead rail, then turn the screw and let the lead rail down. Repeat until the lead rail is at the desired height.*

5. Tighten the securing screws 30-33 ft-lbs.

### *Adjusting the Horizontal Lead Rail Position*

The following procedure is to adjust the horizontal position of the lead rail when the rail is not centered in the case when the awning is closed. This is only necessary if the end plate of the lead rail is rubbing or hitting the end plate of the case.

This procedure is for early models of the Paramount. On newer versions, the lead rail connectors are staked in position to prevent possible shifting and cannot be adjusted

1. (Detail A) With the awning closed as much as possible measure the distance between the inside of the case end plate and the outside of the lead rail end plate. The distance should be approximately 1/4". Note the difference between the actual measurement and the standard 1/4" spacing. This is the amount of adjustment required.

*Example:* If the lead rail overlaps the end plate by 1/8", the difference is  $1/8" + 1/4" = 3/8"$  difference.

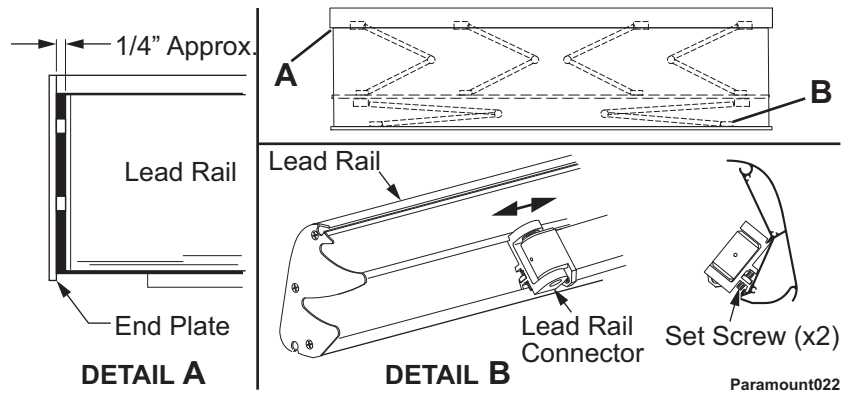

2. Extend the awning out just past the slide-out position. The long arms should be slightly extended to allow access to the lead rail connector.
3. Mark the location of the lead rail connectors for reference then loosen the setscrews that hold the connectors in place.
4. Move the connectors the distance measured in step 1 and tighten the set screws.

**NOTE:** To adjust the lead rail in one direction, move the connectors in the opposite direction. For example to shift the lead rail to the right, move the connectors to the left.

**NOTICE** BOTH connectors must be moved the same distance and direction.

5. Test by closing the awning. Repeat if necessary.



## MANUAL OVERRIDE

If 110V power is not available to the coach, the Paramount awning can still be safely retracted using the manual override.

1. The bypass is located inside the case, near the end cap. Remove the large rubber plug on top of the awning located toward the rear of the case on the motor side.
2. Chuck the 7mm hex key into a 3/8" battery powered drill.
3. Insert the hex key into the manual override on the awning.
4. Operate the drill in the direction shown in the diagram to close the awning. Reverse the drill to open the awning.
5. When done, reinsert the rubber plug.

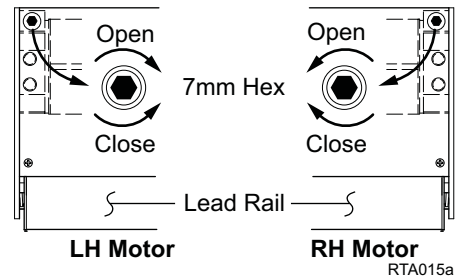

## PROGRAMMING THE RF RECEIVER FOR A REMOTE

When adding or replacing a remote control, it is necessary to program the transmitter and receiver.

1. Power to the control box must be on.
2. Locate the receiver box.
3. Press and release the "Press to Learn Transmitter" button on the bottom of the receiver box. The receiver is in program mode when the red light comes on.
4. Press and release any button on the remote, it is recommended to use the stop button. The red light will go out after the receiver learns the remote signal.

**NOTICE** Any button on the remote may be pressed. When the receiver learns the transmitter signal the system will perform the operation of the button pressed. Example: Pressing an "Extend" button during the learning phase will cause the awning to extend when the receiver learns the signal. Use caution to avoid unexpected movement by the awning.

5. Repeat for each additional remote.

### OPERATIONAL NOTES:

- a. Transmitter and receiver operate on a frequency of 433MHz.
- b. The receiver exits the program mode after ten seconds.
- c. If the light does not come on in step 2, check the continuity of the cord between the boxes and repair or replace as required. Pin 1 of the 1<sup>st</sup> connector goes to pin 1 of the 2<sup>nd</sup> connector etc. If the light still does not come on, the memory is full and must be cleared.
- d. If the light does not go out in step 3, the receiver already knows the transmitter's signal or the battery in the remote needs to be replaced.
- e. To clear the memory: PRESS AND HOLD the transmitter learn button. While holding the button, the indicator light should be OFF for the full 5 seconds then come on.
- f. The system may be programmed for up to 5 remotes. Additional remotes may be ordered separately.

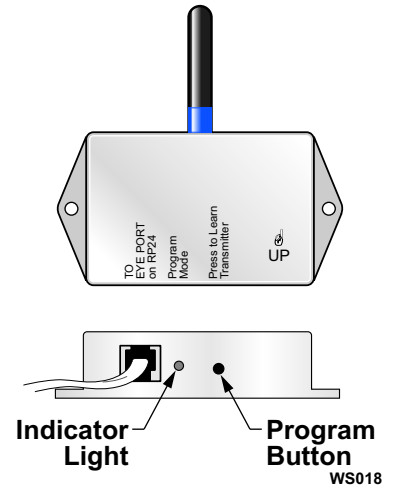

## STANDARD MAINTENANCE

Maintaining a Carefree Awning is easy. Just follow these basic steps:

- Always operate the awning according to the instructions.
- Periodically check that the fasteners are tight. Tighten if necessary.
- Keep the awning fabric and arms clean.

### *Fabric Care*

**NOTICE** Do not use oil based cleaners or any caustic, granulated, or abrasive type cleaners on your Carefree product.

1. One of the best ways to keep the fabric looking good and to delay the need for deep or vigorous cleanings is to hose fabrics off on a monthly basis with clear water. This practice will help prevent dirt from becoming deeply imbedded in the fabric. In most environments, a thorough cleaning will be needed every two to three years.
2. When it's time for a thorough cleaning, the fabric can be cleaned while still on the awning frame.
  - For Vinyl Fabric – Use a soft brush and warm water with soap.
  - For Acrylic Fabric – Use a stiff brush and warm water with soap.
3. When cleaning the fabric, it is important to observe the following:
  - Always use a natural soap, never detergent.
  - Water should be cold to lukewarm, never more than 100°F.
  - Air-dry only. Never apply heat to the fabric.
  - Always allow the fabric to dry thoroughly before rolling up the awning.

### *Mildew*

Mildew is a fungus growth that looks like dirt. Vinyl coated polyester fabrics are mildew resistant because of a chemical biocide in the vinyl coating. Under ordinary conditions, mildew will not appear. However, in areas where high temperature and humidity are common, mildew can be a problem and required the material to be washed more frequently. Thoroughly rinse the fabric with clean water and allow to air dry completely before rolling up the awning.

### *Pooling*

When water collects on the top of the fabric, this is known as "pooling". This can occur during inclement weather or if a running air conditioner discharges over the awning. The water is dumped when the awning is retracted. It is recommended that if water accumulates on the top; retract the awning in steps (8"-12") to dump the water. This will help prevent the fabric from stretching or distorting.

**The effects of wind and rain on an awning are unpredictable. Severe damage to the awning and the vehicle may result. IF WIND OR EXTENDED PERIODS OF RAIN ARE EXPECTED, ROLL UP THE AWNING AND SECURE FOR TRAVEL.**

### *Arm Care*

The best method of keeping the arms operating smoothly is to clean them. Dirt and debris can cause the channels not to pivot easily.

Periodically wash the channels with running water (i.e. a hose) to keep them clean. If the joints do not flex easily, lightly spray the pivot pins with a dry silicone lubricant, after the arms have been cleaned and dried thoroughly.

### *Arm Noise*

After a period of use, the arm knuckle joints may slide together slightly making a squeaking or squealing noise; this is normal and not a reason for concern. To reduce the sound, apply a few drops of light oil (3 in 1 or equivalent) on the knuckle joint seams. Allow some time for the oil to penetrate into the joint.

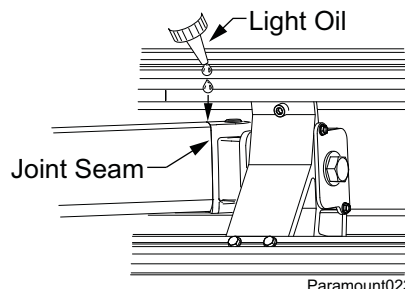

## CANOPY REPLACEMENT

During the following instructions, use the manual override procedure on page 6 to open and close the awning.

1. Disconnect power to the awnings.
2. Open the awning to be serviced 18"-24" inches to expose the arm elbows.
3. Using a minimum 1/2" rope, firmly tie the elbows of the outer spring arms together, do not use bungee cords. When tying the rope, use a non-slip knot such as a square knot or equivalent.
4. Use rope or heavy duty plastic ties (3/8" x 12") to tie the long arms and middle rail together in the closed position.

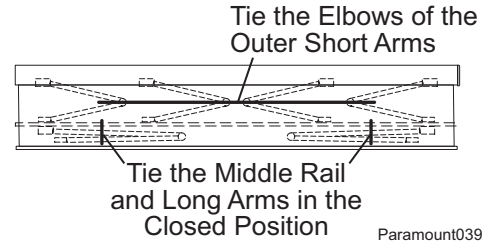

Paramount039



**CAUTION** Failure to secure the arms as described will allow the spring arms to extend out possibly causing personal injury and damage to the awning.

5. Remove the two fabric retainer screws on both ends of the lead rail and set aside.
6. Remove the top screws holding the top cover. Rotate the top cover back and out of the way. If rotated back without obstructions, the top cover will disengage from the pivot rail and can be set aside.
7. Use the manual override (page 7) to unroll the canopy until the fabric slot is exposed on top of the roller tube.
8. Remove the access plug from the top of the idler end plate.
  - 8.1. For one-piece end plates, it is necessary to remove the idler end plate and set aside.



Paramount016a

**NOTE:** It will be necessary to support the roller tube, do not allow the roller tube to pull off the motor.

9. From the idler side, slide the old canopy out of the roller tube and lead rail.
10. Inspect the slots in the roll bar and lead rail. Clean and deburr as required. Lightly spraying the inside of the slot with a dry silicone lubricant will aid in sliding the new fabric in.
11. Slide the new canopy into the lead rail and roller. Both edges must be done at the same time. Orient the fabric so that the large polycord goes into the lead rail, the smaller polycord goes into the roll bar. The hem should be on the down side.
12. The canopy should be approximately .25" from the end of the motor crown.
13. If previously removed, attach the end plate to the case with the roller tube idler seated into the bearing.
14. On the idler side, stake the canopy with one (1) #8 x 1" flat head screw. The screw goes through the material, polyrod and roller tube in the fabric slot.

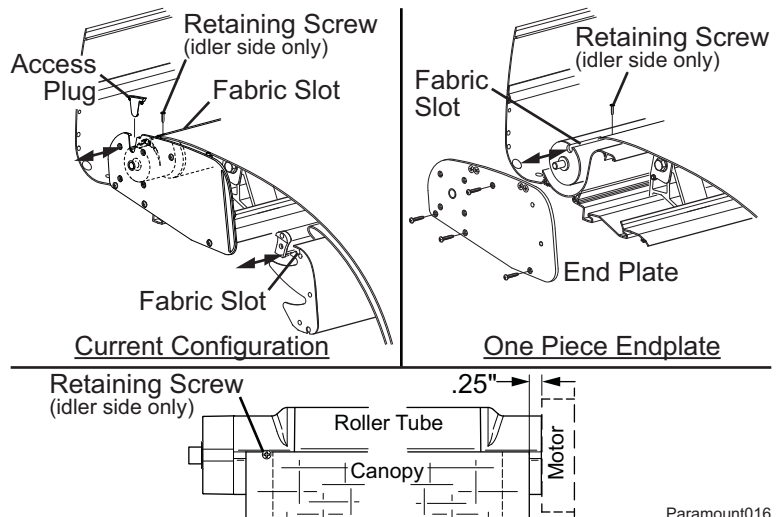

Paramount016

15. Use the manual override to roll the canopy onto the roller tube, the material rolls over the top of the roll bar. Ensure the fabric rolls evenly onto the roller tube.
16. Once the fabric is snugly rolled up, remove the rope used to secure the arms previously.
17. Restore power to the awning.
18. Extend and retract the awning. Adjust the canopy in the lead rail as required.
19. Install the fabric retainer screws in the lead rail.
20. It may be necessary to adjust the motor limits. Refer to page 3.
21. Install the top cover.

## MOTOR REPLACEMENT



**WARNING** Shock Hazard. Always disconnect battery or power source before working on or around the electrical system.

**Important Note:** The current replacement motor has a slightly different configuration for the limit switch locations. The new motor is orange and has different graphics around the limit switches (see page 3 for comparison). If replacing an older configuration motor, it will be necessary to modify the top cover limit switch access holes. This modification should be done prior to removing and replacing the motor to avoid damaging the new motor. See “Modifying the Top Cover” on page 13.

This procedure requires a minimum of two people.

For multiple awning installations where the awnings are mounted end to end it will be necessary to move the unaffected awning if the motors are next to each other.

1. Disconnect power to the awning(s).
2. To move an adjacent unaffected awning:
  - 2.1. Close the awning if open.
  - 2.2. Loosen the retaining bolts in the back of the mounting plates.
  - 2.3. Slide the awning away from the other awning; allow a minimum of 6" to 8" between awnings.
  - 2.4. Temporarily tighten at least one of the retaining screws.

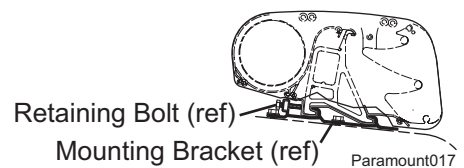

### **Replacing the motor:**

1. Disconnect power to the awning.
2. Disconnect the motor wires at the junction box or control box and pull the cable out.
3. Use the manual override (refer to page 7) to over extend the awning. The arms should be extended completely, the canopy should be relaxed and the fabric slot of the roller tube should point up.

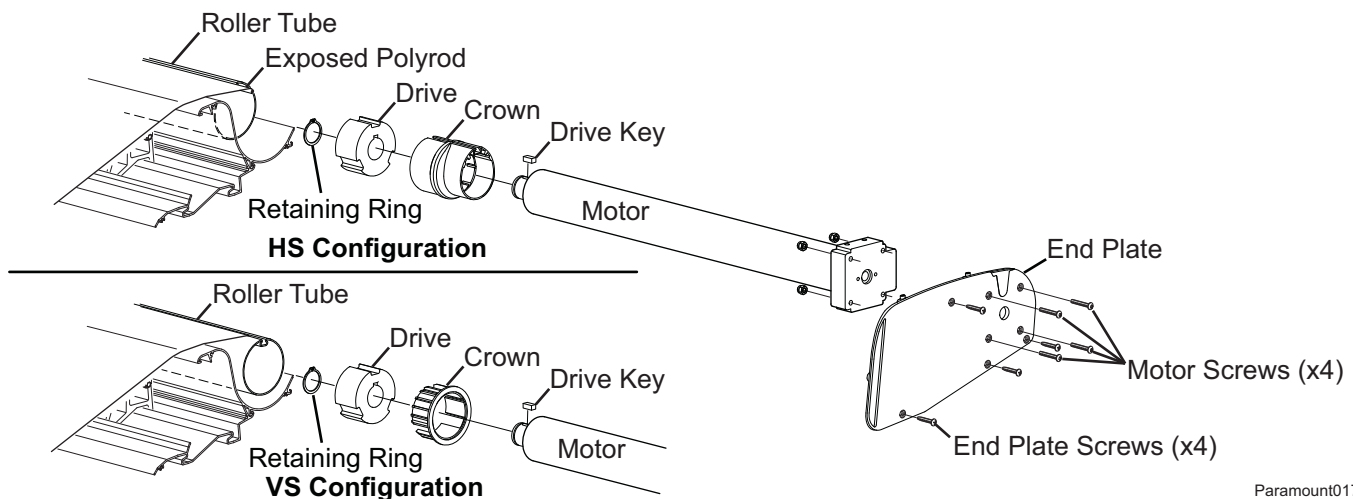

4. Remove the top screws holding the top cover. Rotate the top cover back and out of the way. If rotated back without obstructions, the top cover will disengage from the pivot rail and can be set aside.
5. Remove the attaching screws for the end plate then carefully pull the end plate and motor partially out from the awning case.
6. Remove the screws and nuts holding the motor to the end plate. Set the end plate aside. Note the orientation of the motor then pull the motor, crown and drive out of the roller tube.

**Note:** *For the HS configuration:* When the crown is removed the canopy edge with the polyrod will be exposed and extend past the roller tube.

7. *For HS configuration:* Remove the crown from the old motor. This will be used with the new motor. The crowns are configuration specific.

## 8. Assemble the new motor:

**NOTE:** The new and old motor components are not interchangeable.

## 8.1. Slide the crown onto the motor.

**NOTE:** For VS configurations, use the new crown that is included with the motor. For HS configurations, discard the included crown and use the existing crown that was removed previously.

## 8.2. Place the drive key into the slot of the motor shaft and slide the new drive onto the motor shaft and over the drive key.

## 8.3. Secure the drive using the supplied retaining ring.

## 9. Attach the new motor assembly to the end plate using the new screws and nuts provided.

## 10. Slide the new motor assembly into the roller tube. Ensure that the motor drive gear and crown are properly seated inside the roller tube.

**NOTICE** ***For the HS configuration:*** When the crown is seated in the roller tube, the canopy edge with the polyrod must be in the fabric groove of the crown.

## 11. Route the motor cable through the access hole in the back of the case.

## 12. Ensure the roller tube idler plug is seated in the glide bearing.

## 13. Position motor end plate on the case and attach using the screws removed previously.

14. Route the new motor wire into the coach and attach (refer to wiring diagrams on page 20 for the appropriate control system). Ensure that the wire colors match (i.e. red to red and black to black). **All wiring must conform to NEC (National Electrical Code) and local codes.**

## 15. Use the manual override to begin rolling the canopy onto the roller tube, the material must roll over the top of the roller tube. Ensure the fabric rolls evenly onto the roller tube.

## 16. Restore power to the awning.

## 17. Extend and retract the awning.

## 18. It will be necessary to adjust the motor limits. Refer to page 3.

## 19. Install the top cover.

## 20. Reposition the adjacent awning if it has been moved. Ensure that all the retaining bolts are properly tightened to 10 ft-lbs.

## 21. After replacing the motor, it is recommended that a calibration routine is run on the affected awning because of possible variations in motor performance. Refer to page 4.

## MODIFYING THE TOP COVER

When replacing an older configuration motor with the current motor, it is necessary to modify the top cover access holes for the limit switches.

1. Remove and save the two (3) small plugs from the top of the cover.
2. Measure and mark the new hole locations.
3. Drill two (2) 3/8" holes through the cover in the locations marked.
4. Clean and deburr the holes.
5. Insert the two plugs removed previously into the previous holes.
6. Insert the new plugs into the new holes. The plugs will overlap.
7. Open the top cover and continue with the motor replacement. Clean any shavings that may have fallen into the case.

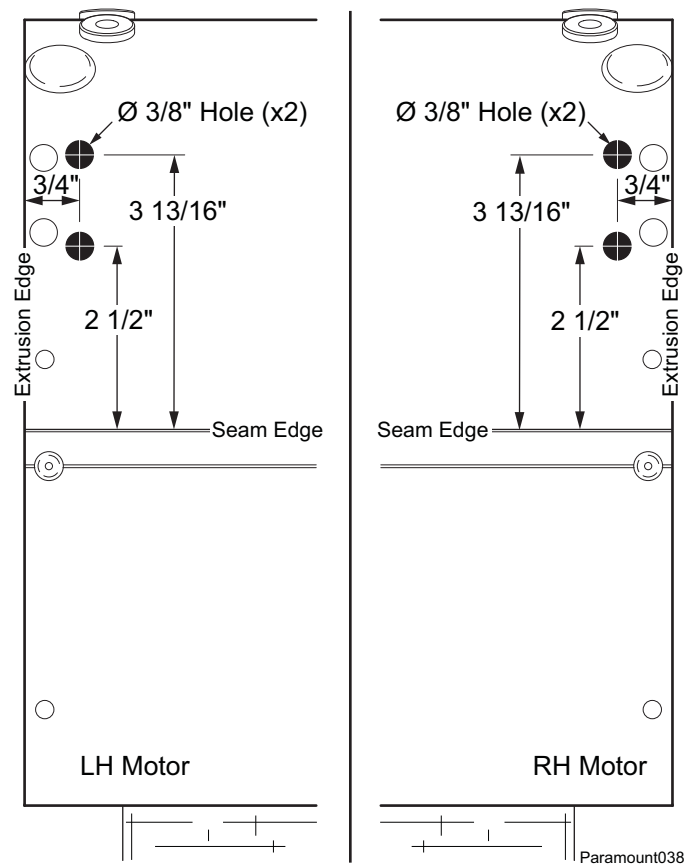

Paramount038

## SHORT SPRING ARM REPLACEMENT

**CAUTION** The spring arm is under tension to open. Use extreme care to firmly hold the spring arms during assembly and disassembly to avoid any sudden or unexpected movement by the arm. Serious personal injury and/or property damage could occur.

**IMPORTANT NOTE:** The outer short arms are provided as a set. For correct awning operation, both the outer arms must be replaced at the same time.

**NOTE:** Two styles of case knuckles are used on the Paramount short arms. Early units use the 1-piece knuckle. Later models use the knuckle with positioning pins. Replacement arms use the knuckle with positioning pins.

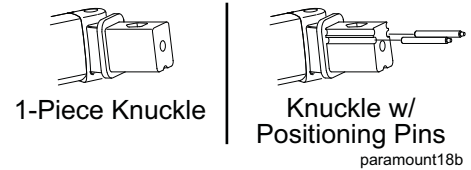

### Removing the Existing Arm

1. Extend the awning out to the Slide-Out Cover position.
2. Disconnect power to the awning.
3. For arms with the sensor cable mounted, carefully remove the sensor cable from the wire channel on top of the arm. Use care to not bend, break or compromise the cable.
4. (Refer to Detail A) Remove the 1/2-13 bolt and washers from the frame mount. Save the screw and washers.
5. For knuckles with pins: Remove the knuckle plate and screws. If installed, remove the positioning pins. It may be necessary to gently lift and pull the arm to slide the pins out of the housing.
6. While firmly holding the arm, pull the arm knuckle out of the housing.
7. Fold the arm together and securely tie the arm closed. Use a 3/8" x 12" plastic tie or equivalent.
8. Rotate the arm so that it is parallel with the middle rail to provide access to the setscrew in the arm knuckle.
9. (Refer to Detail B) Loosen the setscrew then remove rotation pin from the arm knuckle. Save the pin.
10. Remove the arm from the awning.
11. On a work surface, rotate the knuckle to provide access to the setscrew located in the knuckle.
12. (Refer to Detail C) Loosen the setscrew and remove the rotation pin from the arm knuckle. Save the knuckle, screw and pin.

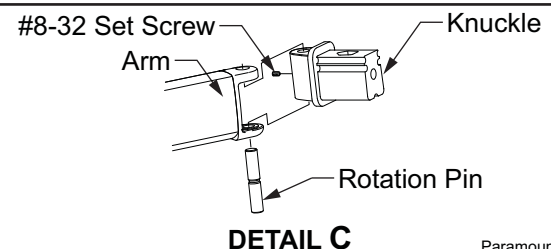
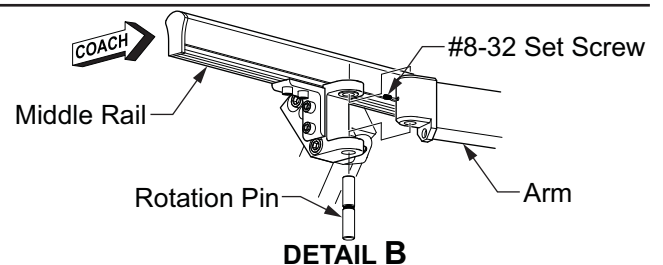
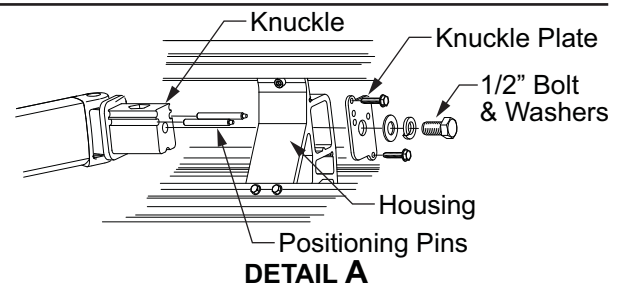
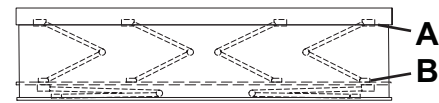

Paramount018d



## Installing the New Arm

The new arm is banded in the closed position. Do not remove the binding until instructed to do so.

1. (Refer to Detail C) Attach the knuckle on the new arm using the rotation pin removed previously. Ensure that the groove in the pin aligns with the setscrew before tightening.
2. (Refer to Detail B) Attach the arm to the middle rail joint using the rotation pin and setscrew removed previously. Ensure that the groove in the pin aligns with the setscrew.
3. Firmly hold the arm together and remove the binding. Allow the arm to open slowly.



**CAUTION** When the arm is closed, it can open with significant force. Use care when opening the arm.

4. (Refer to Detail A) Slide the arm knuckle into the frame mount.
5. For models with the 1-piece knuckle:
  - Slide the knuckle into the housing. Attach the knuckle to the mount using the 1/2-13 bolt, washer and lock washer removed previously.
6. For models with positioning pins:
  - Liberally coat the positioning pins with quality silicone grease.
  - For awnings under 19' long, two (2) pins are used for the inner and outer arms in the positions shown. For awnings 19' and longer, the inner arms use the two pins, the outer arms use one (1) pin in the position shown.
  - Slide the positioning pins into the housing with the knuckle. It may be necessary to gently lift the arm up or down to slide the pins into the housing with the knuckle.
  - Attach the knuckle plate to the housing using the screws removed previously.
  - Attach the knuckle to the mount using the 1/2-13 bolt, washer and lock washer removed previously.

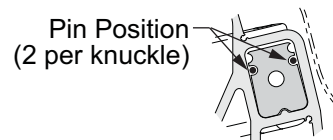

Pin Position  
(2 per knuckle)

For All Inner Arms &  
Outer Arms In Units under 19'

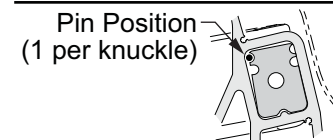

Pin Position  
(1 per knuckle)

For Outer Arms In Units over 19'

Paramount018c

**NOTE:** All replacement arms have a wire channel groove in the top of the extrusion. The wire is routed in the groove and retained using a cord retainer that is wrapped around the wire and pressed into the groove.

7. Route the sensor cable on the replacement arm:
  - Place a 3" piece of cord retainer onto the cable and press into the groove on top of the arm. Ensure that the open side of the retainer is facing in toward the channel. Repeat at each end and in the center of the channel.
  - At the arm joints, arch the cable slightly to avoid binding. Do not twist the cable.

**NOTICE** Never attempt to adjust or alter the middle rail and attached components. Never attempt to move or adjust the arm knuckles in the case or on the middle rail; these have been pre-set at the factory for optimum operation.

## LONG SPRING ARM REPLACEMENT

**CAUTION** The spring arm is under tension to open. Use extreme care to firmly hold the spring arms during assembly and disassembly to avoid any sudden or unexpected movement by the arm. Serious personal injury and/or property damage could occur.

### Removing the Existing Arm

**NOTE:** Use a scaffold, ladder or other means to firmly support the lead rail while removing the arm and installing the replacement.

1. Extend the awning out fully.
2. Disconnect power to the awning.
3. For arms with the sensor cable mounted, carefully remove the sensor cable from the wire channel on top of the arm. Use care to not bend, break or compromise the cable.
4. (Refer to Detail A) Firmly hold the arm while removing the set screw and rotation pin from the middle rail knuckle.
5. Fold the arm together and securely tie the arm closed. Use a 3/8" x 12" plastic tie or equivalent.
6. Rotate the arm so that it is parallel with the lead rail to provide access to the set screw located in the arm knuckle.
7. (Refer to Detail B) Remove the set screw and rotation pin from the arm knuckle. Remove the arm from the awning and set aside.

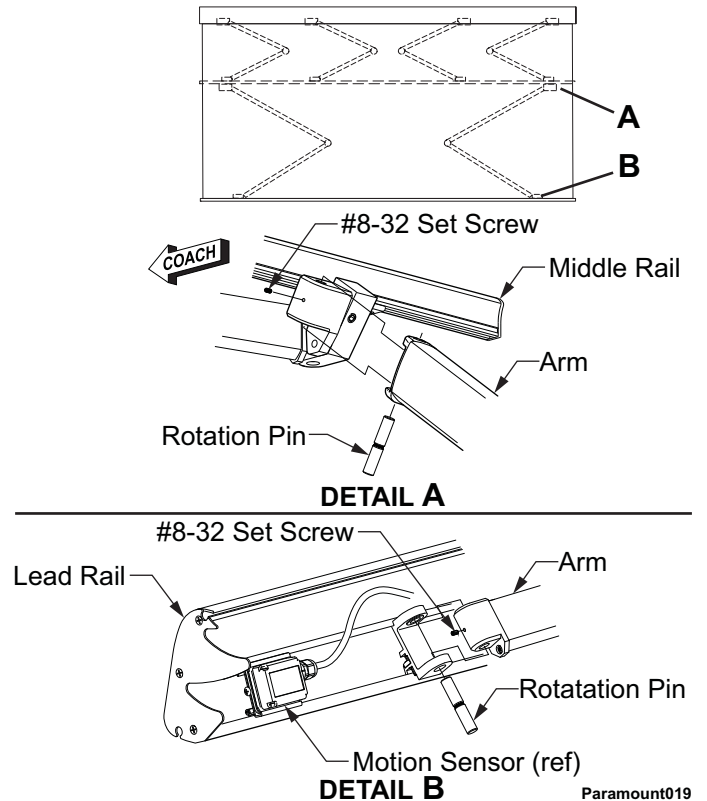

### Installing the New Arm

**The new arm is banded in the closed position. Do not remove the binding until instructed to do so.**

1. (Refer to Detail B) Attach the new arm to the lead rail connector using the rotation pin and set screw removed previously. Ensure that the groove in the pin aligns with the setscrew.
2. Firmly hold the arm together and remove the binding. Allow the arm to open slowly.
3. (Refer to Detail A) Attach the arm to the middle rail knuckle using the rotation pin and set screw removed previously. Ensure that the groove in the pin aligns with the set screw.

**NOTE:** All replacement arms have a wire channel groove in the top of the extrusion. The wire is routed in the groove and retained using a cord retainer that is wrapped around the wire and pressed into the groove.

4. Route the sensor cable on the replacement arm:
  - 4.1. Place a cord retainer onto the cable and press into the groove on top of the arm. Ensure that the open side of the retainer is facing in toward the channel. Repeat at each end and in the center of the channel.
  - 4.2. At the arm joints, arch the cable slightly to avoid binding. Do not twist the cable.

## REMOVING THE AWNING



**The Paramount awning is extremely heavy. Moving and/or lifting the awning requires a minimum of 3 people. The use of a lifting device is strongly recommended.**

1. Retract the awning completely.
2. Disconnect power to the awning.
3. Locate the junction box where the motor wires are routed. Disconnect the motor wires and remove from the junction box. Make note of the wire colors. Bundle the wire to the awning.

**NOTE: Some installations use a waterproof junction box located on the top of the coach, others may have the junction box located inside the coach at or near the cable entry point.**

4. Disconnect the sensor cable.
  - For installations with a junction box: Some installs may route the cable into a junction box with a cable coupler. Disconnect the cable from the awning and remove from the junction box. Bundle the cable to the awning.
  - For installations hardwired to the control box (option 1): Trace the cable to the control box. Disconnect the cable from the control box and remove from the coach. Bundle the cable to the awning.
  - For installations hardwired to the control box (option 2): If it is not possible to disconnect the cable from the control box and remove from the coach, locate the cable inside the coach and at a convenient point, cut the cable. Pull the cable out and bundle to the awning. If using this method, it will be necessary to order a cable coupler and two phone cable connectors when reinstalling the awning.
5. The awning is mounted using 4 mounting brackets attached to the roof of the coach. Each mounting bracket has a retaining bolt in the back side to hold the awning into the bracket. Loosen all 4 of the retaining bolts. It is not necessary to remove the bolts from the brackets.
6. Slide the awning back and up to remove the awning from the brackets.
7. To reinstall the awning, reverse the procedure above.

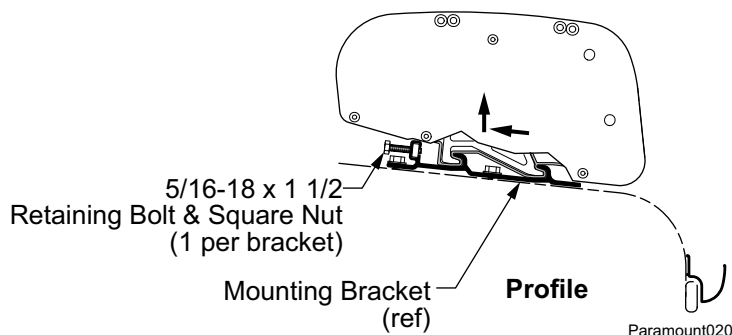

Paramount020

### Special Notes:

- a) When attaching the motor wires ensure that the wire colors match the previous configuration. All wiring must conform to NEC (National Electrical Code) and local codes.
  - b) If the sensor cable was cut to remove the awning, it is necessary to install a connector on each cut end of the cable. The connector must be attached as shown in the wiring diagrams. A coupler is then used to attach the two connectors.
8. After installing the awning, test the operation (refer to page 19). It may be necessary to adjust the lead rail height (refer to page 6).

## DIAGNOSTIC TESTS

The following procedures are intended to aid the service technician to logically resolve operational issues with the *Direct Response* installation.



**! WARNING** Shock Hazard. Always disconnect battery or power source before working on or around the electrical system.

*Refer to the appropriate wiring diagram:*

- Wiring Diagram – Single Awning      page 23
- Wiring Diagram – 2 - Awnings        page 23
- Wiring Diagram – 4 - Awnings        page 26

<i>Procedures in this section:</i>	<i>Page</i>
<b>COMMON OPERATIONAL ITEMS .....</b>	<b>18</b>
<b>TESTING THE SYSTEM.....</b>	<b>19</b>
<b>D01 - THE AWNING(S) OPERATE DIFFERENT THAN THE SWITCH MARKINGS.....</b>	<b>20</b>
<b>D02 - THE AWNINGS DO NOT OPERATE (ALL).....</b>	<b>20</b>
<b>D03 - ONE AWNING DOES NOT OPERATE .....</b>	<b>21</b>
<b>D04 - AWNING(S) DO NOT RETRACT DURING WINDY CONDITIONS .....</b>	<b>22</b>
<b>D05 – AWNING(S) DO NOT MOVE WHEN REMOTE CONTROL BUTTONS ARE PUSHED.....</b>	<b>22</b>

### COMMON OPERATION ITEMS

The following items are operational items that may come up as questions during normal operation. These are also given in the operator's manual.

1. Each awning has an independent motion sensor. During windy conditions, the awnings may not retract concurrently.
2. The auto-retract system functions in two stages. The first stage is when the awning is extended past the slide-out position. The awning will retract and stop at the slide-out cover position to provide continued protection for the slide-out room.

When in the slide-out cover position, the awning is very robust. The auto-retract system is active but uses a higher factory preset threshold value for extreme weather conditions. When the motion of the awning exceeds the extreme weather threshold, the awning will close to the full retract position. The second stage sensitivity (threshold) value is not controlled by the keypad settings.

3. If an optional EL ignition lockout is installed, the system will disable the extend function while the vehicle ignition key is in the ON position. If the RTL ignition lockout with retract is installed, the awning will retract to the closed position and disable the extend function. Operation will return to normal when the key is OFF.
4. If the AC power source is disrupted while the awning is moving, the awning will stop. When power is restored, extend and retract functions will operate normally. Pressing an intermediate stop (slide-out and window) the awning will first retract then go to the selected position.
5. The awning motor is equipped with a thermal protection circuit to protect the motor from overheating. Operating the awning repeatedly over a short time period may cause the circuit to sense a overheat condition and shut off the motor. If this occurs, wait approximately 15 minutes to allow the motor to cool then operate the awning in normal fashion.

## TESTING THE SYSTEM

All function buttons are press ON. The auto-functions continue until the awning is fully extended or retracted. Pressing the button a second time will stop the function (does not apply to the "Extend All" or Retract All" commands). It is not necessary to hold the button while the function is active.

1. While observing the control panel, have a second person initiate 110VAC power to the coach and awning system. The following should occur:
  - 1.1 The System Indicator and Sensitivity Level LEDs will briefly illuminate.
  - 1.2 The system then goes to the default settings: The default settings are the last known state when the AC power source was suspended. Example: If power was "ON" and the sensitivity was set to "2", when AC power is applied, power will be on and sensitivity will be set to "2".
2. If ON press the POWER "OFF". ALL LEDs should be extinguished. The POWER ON/OFF button disables all functions including Auto-Retract and the RF remote. It does not disconnect the 110VAC power.
3. Check the extend function.
  - 3.1 Press the POWER "ON".
  - 3.2 Press the Awning #1 EXTEND button. The awning should extend.
  - 3.3 Press the extend button again. The awning should stop
  - 3.4 Press the extend button a third time. Observe the awning, it should fully extend. The system performs an auto-tension action when the awning is fully extended. The awning rolls in reverse to tension the fabric. The auto-tension feature works only with the extend function when the awning is fully extended.
4. Check the retract function.
  - 4.1 Press the Awning #1 RETRACT button. The awning should retract.
  - 4.2 Press the retract button again. The awning should stop
  - 4.3 Press the retract button a third time. Observe the awning; it should fully retract to the closed position.

**NOTE: If the awning moves in the opposite direction than the label, the red and black MOTOR wires are reversed in the control box.**
5. Repeat steps 3 and 4 for each of the Extend/Retract button combinations.
6. Test the mid-position functions. Press and release each mid position button (Slide-Out cover and Window). The awning should extend or retract to the specified position.
7. Test the Auto-Retract function:
  - 8.1 Fully extend awning #1.
  - 8.2 Set the WIND SPEED to the lowest setting.
  - 8.3 Create a firm but gentle vertical rocking motion with the leading edge of the awning. The awning should retract after 2-3 seconds of the motion. The awning will retract to the slide-out position.
8. Repeat step 6 for each of the awnings.
9. *If the optional Ignition Sensor is installed:*
  - 10.1 Partially retract the awning.
  - 10.2 Turn the vehicle ignition key ON.
  - 10.3 If the RTL lockout is installed, the awning(s) will retract.
  - 10.4 Press the EXTEND button. The awning(s) should not extend.

In the charts below, YES is a positive response to the test; NO is a negative response.

<b>D01 THE AWNING(S) OPERATE DIFFERENT THAN THE SWITCH MARKINGS</b>			
<i>The power switch at the key pad must be on; the LED will be illuminated if power is present.</i>			
<b>A</b>	Does a different awning move when pressing the controls are pressed (i.e. Awning #2 moves when Awning #1 is pressed)? Board marked "Motor 1" corresponds with key pad "Awning 1" etc.	YES	Awning #Y moves when Awning #X buttons are pressed. - Awning motor wires from Awning #X and Awning #Y are reversed. Remove motor wires from control boards, reattach motor #X wires to motor #X control board; motor #Y wires to motor #Y control board.
		NO	Go to test B
<b>B</b>	Does the awning operate in reverse of the switch plate labeling (i.e. extends when retract is pushed)	YES	Motor wires from affected awning are reversed in control box. - Open control box and locate motor wires from affected awning. Reverse the red and black wires. <b>NOTE:</b> <u>For LH motor configurations:</u> RED WIRE goes to terminal (1); BLACK WIRE goes to terminal (2).  <u>For RH motor configurations:</u> BLACK WIRE goes to terminal (1); RED WIRE goes to terminal (2).
		NO	Reanalyze condition

<b>D02 THE AWNINGS DO NOT OPERATE (ALL)</b>			
<i>For one awning that does not operate, refer to D03</i>			
<b>A</b>	Confirm 110VAC power to control box 1. Shut off power source. 2. Open control box. 3. On some early units a fuse is installed on the circuit board. Check that fuses on circuit boards are intact. 4. Check that 110VAC connections and splices to the boards are correct and secure. Refer to system schematics. 5. While observing the circuit boards, have power restored. The LEDs on the boards should blink red then green.	YES	Power is present; go to test B
		NO	Check vehicle circuits and fuses. Repair as required and retest
<b>B</b>	Confirm that key pad is operating.		
	1 Press the "Power On" button on the key pad. The "Indicator" LED should illuminate.	YES	Power is on, go to step B-3
		NO	LED does not illuminate, go to step B-2
	2 Check the cable between the keypad and control box. As a continuity check, Pin 1 of connector 1 goes to Pin 1 of connector 2; pin 2 goes to pin 2; pin 3 goes to pin 3 and pin 4 goes to pin 4.	YES	Continuity OK; go to step B-3
		NO	Replace cable and retest
	3 4.1 Disconnect jumper cable between controller boards. 4.2 Disconnect key pad from "ACC" of controller #1 and connect to "ACC" of controller #2. 4.3 Does Awning #2 operate when pressing a command button on the key pad?	YES	Awning operates, Controller #1 is defective – Replace control box.
		NO	Awning does not respond, key pad is defective - replace

<b>D03 ONE AWNING DOES NOT OPERATE</b>			
NOTE: The awnings are programmed sequentially (i.e. #1, #2, #3, #4). If power is missing from an awning, the subsequent awnings will not function (i.e. #1 and #2 works, #3 and #4 don't). Check the power to the first non functioning control board in sequence (i.e. #3) and correct as necessary before proceeding.			
<b>A</b>	<ol style="list-style-type: none"> <li>1. Shut off power source if not already done.</li> <li>2. Open control boxes and disconnect the non-working awning motor wires and a working awning's motor wires.</li> <li>3. Connect the non-operating awning to the functioning control board (i.e. awning #2 to control board #1).</li> <li>4. Restore power</li> <li>5. Test the operation of the awning using the controls for the functioning awning (in the example above #1 awning).</li> </ol>	YES	Awning functions, control board of non-working awning is defective – replace control box.
		NO	Return wires to original configuration. Go to step B
<b>B</b>	Confirm awning motor is functioning		
	<ol style="list-style-type: none"> <li>1.               <ol style="list-style-type: none"> <li>1.1 With power off, disconnect motor wires and AC power in from switches (system #1) or control box.</li> <li>1.2 Connect awning motor directly to 110VAC power source.                    Motor White to Neutral (White) of AC cord                    Motor Green to Ground (Green) of AC cord                    Motor Red &amp; Black are Motor Direction Control – connect Red to AC Hot (Black).</li> <li>1.3 While observing awning, briefly apply power.</li> <li>1.4 Disconnect power and attach other motor direction control wire (Black) to AC Hot (Black).</li> <li>1.5 While observing awning, briefly apply power.</li> <li>1.6 Does awning move when power is applied?</li> </ol> <p><b>Note:</b> If the awning runs but does not extend or retract completely, it may be necessary to adjust the motor limits (refer to page 3).</p> </li> </ol>	YES	Awning motor is good, control box is defective - replace
		NO	Go to step B-2
	<ol style="list-style-type: none"> <li>2. Test continuity and connections of motor wire between control box and awning motor.</li> </ol>	YES	Continuity is good, motor is defective – replace
		NO	Repair as required and retest

<b>D04 AWNING(S) DO NOT RETRACT DURING WINDY CONDITIONS</b>			
<i>The Direct Response auto-retract system operates by gauging the motion of the awning's leading edge, not by the direct wind speed. Refer to the description in the owner's manual.</i>			
NOTE: The awnings have independent sensors and may not retract concurrently.			
<b>A</b>	Press the power on button then press the auto-retract button. Does the indicator LED flash (slow pulse)?	YES	The flashing LED indicate that the sensor(s) have been disengaged or other wise disabled. Go to step C
		NO	Go to test B
<b>B</b>	Confirm standard awning operation. From the key pad, operate the awnings.	YES	Operation is normal, Go to step C
		NO	Refer to the appropriate test D02 or D03
<b>C</b>	Check function of shaker sensor 1. Open the affected awning (does not have to be open all the way). 2. Open the second awning. 3. Open control box and disconnect sensor from controller board of awning that does not auto-retract. 4. If cable has been spliced between sensor and control box, check continuity of splice. Repair as required and retest before proceeding. 5. Disconnect the sensor from the other controller and plug the cable into the "SHAKE" terminal of the affected awning controller. 6. At key pad, turn power ON and auto-retract ON. 7. Set auto-retract to the lowest setting. 8. At the unaffected awning, create a firm but gentle rocking motion with the leading edge of the awning for about 3-4 seconds.	YES	The affected awning retracts. Original sensor is defective replace. Return second shaker to the unaffected awning controller.
		NO	Awning does not retract, control box is defective – replace
NOTE: The key pad LEDs will continue to flash after connecting good sensors. It is necessary to power off the system then turn it back on so that the key pad recognizes the sensors are connected			

<b>D05 AWNING DOES NOT MOVE WHEN REMOTE CONTROL BUTTONS ARE PUSHED</b>			
	1. Confirm power is ON at the key pad	--	Correct as required
	2. Confirm batteries in remote are good. Pressing any button on the remote will illuminate the LED at the top of the remote.		Replace as needed
	3. Check the cable between the Receiver and control box. As a continuity check, Pin 1 of connector 1 goes to Pin 1 of connector 2; pin 2 goes to pin 2; pin 3 goes to pin 3 and pin 4 goes to pin 4. Cable must be plugged into the "BUS" port of controller #1.	YES	Cable is OK. Confirm that cable is securely plugged in; go to step 4
		NO	Repair or Replace cable as required.
	4. Confirm that the Receiver is programmed for the Remote	--	Refer to "Programming the Receiver" on page 8 and retest. If system does not work; go to step 5
	5. Program a second remote and test	YES	2 <sup>nd</sup> remote works. 1 <sup>st</sup> remote is defective.
		NO	2 <sup>nd</sup> remote does not work; go to step 6
	6. Replace the Receiver and test. (it will be necessary to program receiver for remote)	YES	System works OK. 1 <sup>st</sup> receiver is defective
		NO	System does not work. Reinstall 1 <sup>st</sup> receiver; go to step 7
	7. Replace control box	--	



ELECTRONICS

WIRING DIAGRAM – SINGLE AWNING

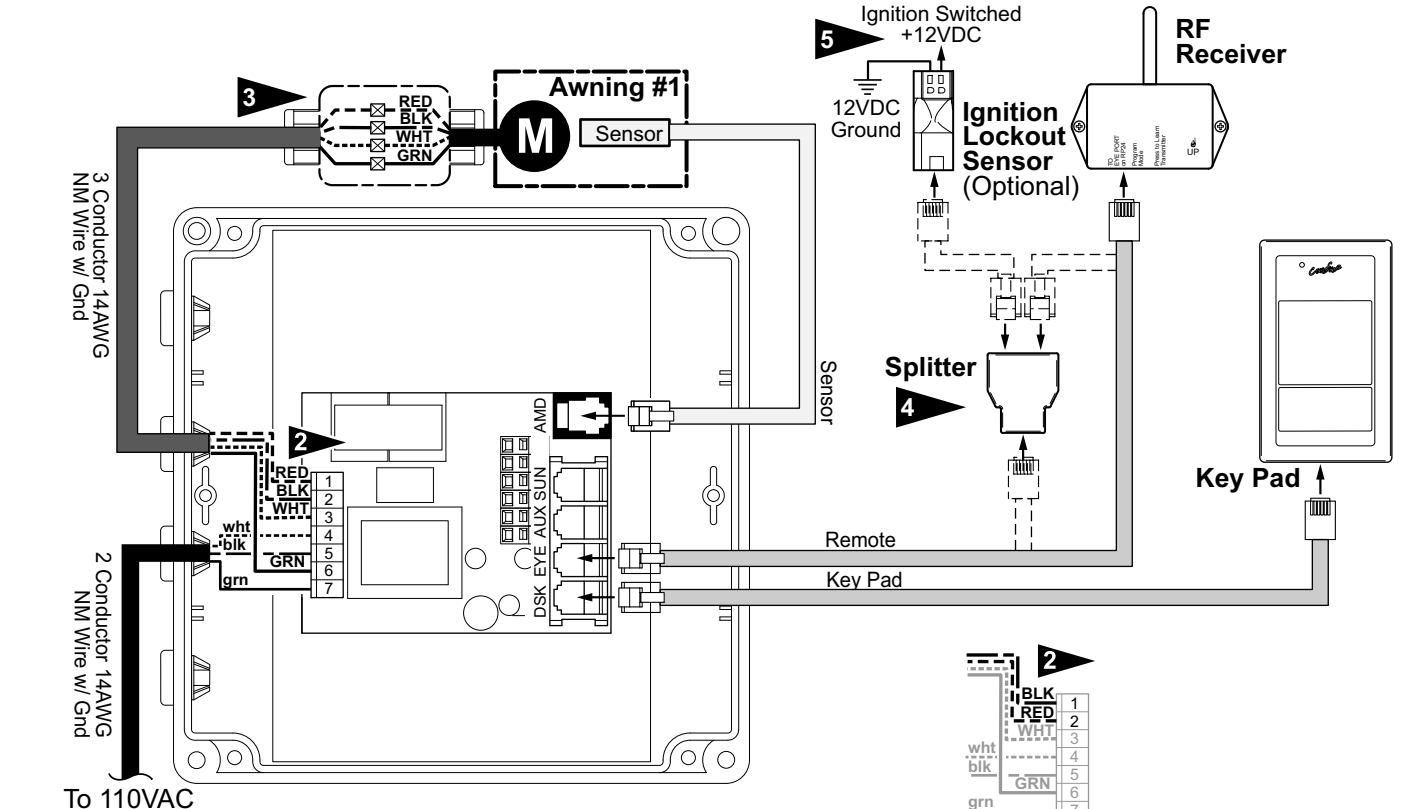

NOTES:

- 1 Wire Legend:
  - Red
  - Black
  - White
  - Green (Ground)
- 2 For LH Motor Configurations:
  - Motor Red goes to Pin (1); Motor Black goes to Pin (2)
 For RH Motor Configurations:
  - Motor Red goes to Pin (2) Black; Motor Black goes to pin (1)
- 3 The SO cable from the 110VAC awning motor can only pass through a wall, it cannot be laid up in the wall and must be connected to NM wire or individual wires in conduit no more than 6 inches past the point of entry.
- 4 Splitter is used only when Optional Lock-Out Sensor is installed. Connect RF Receiver directly to "EYE" if Lock-Out is not installed.
- 5 Wires for the Ignition Lock-Out Sensor are not pin specific.

**Detail A**  
For RH Configuration  
Reverse Red & Black Wires

DR013

	FROM	To (RH CONFIGURATION)		To (LH CONFIGURATION)	
Motor	Black	Control Box	1	Control Box	2
	Red		2		1
	White		3		3
	Ground		6		6
AC Power Source	White	Control Box	4	Control Box	4
	Black		5		5
	Ground		7		7
Awning Sensor	10' Cable	Control Box	"AMD"	Control Box	"AMD"
Key Pad	60" Cable	Control Box	"DSK"	Control Box	"DSK"
Splitter	60" Cable	Control Box	"EYE"	Control Box	"EYE"
RF Receiver	60" Cable	Splitter		Splitter	
Ignition Lockout	60" Cable	Splitter		Splitter	

Phone connector is shown on page 25.

WIRING DIAGRAM - 2-AWNINGS

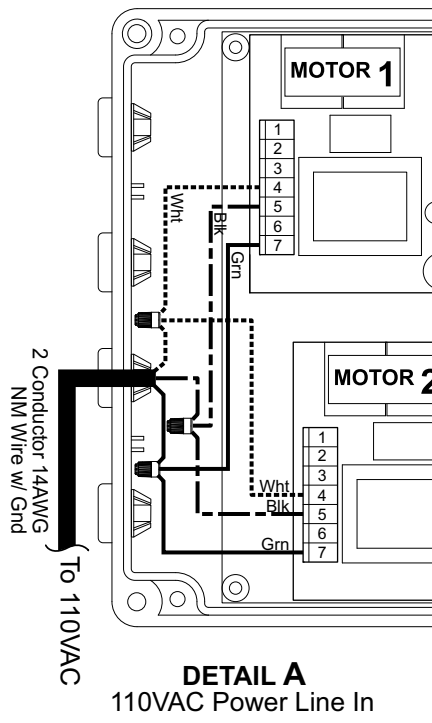
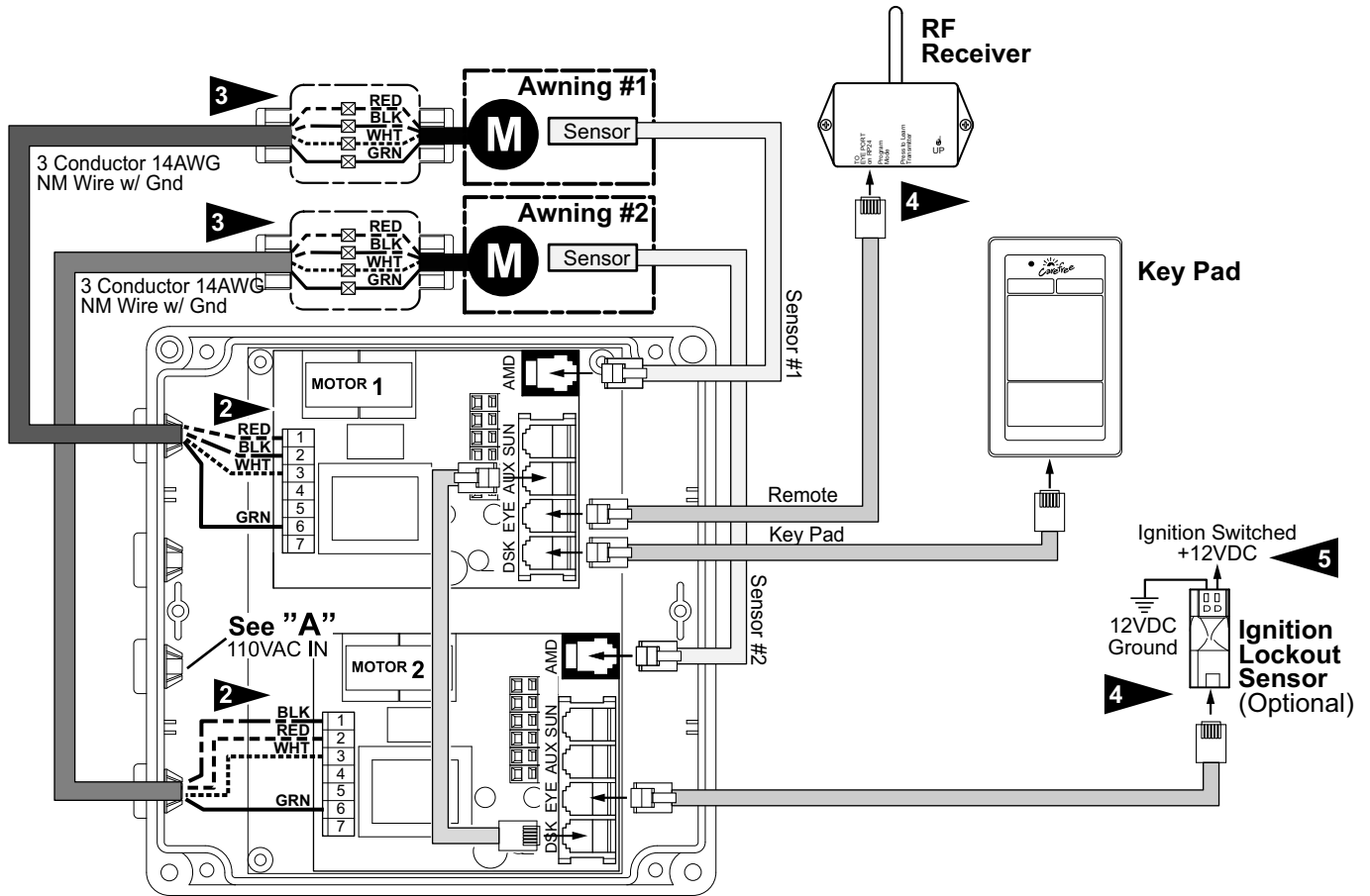

DR014a

**NOTES:**

- 1 Wire Legend:
  - Red
  - Black
  - White
  - Green (Ground)
- 2 Awnings #1 & #4 shown as LH Motor, Awnings #2 & #3 shown as RH Motor
  - For LH Motor Configurations:**  
Motor Red goes to Pin (1); Motor Black goes to Pin (2)
  - For RH Motor Configurations:**  
Motor Red goes to Pin (2); Motor Black goes to pin (1)
- 3 The SO cable from the 110VAC awning motor can only pass directly through a wall, it cannot be laid up in the wall and must be connected to NM wire or individual wires in conduit no more than 6 inches past the point of entry.
- 4 The RF Receiver and the optional Ignition Lockout may be plugged into any open "EYE" port.
- 5 Wires for the Ignition Lock-Out Sensor are not pin specific.
- 6 For screw type terminals: After testing connections, use Loctite 29005 or equivalent to secure screws in terminal block.
- 7 Cables are 4-wire RJ11 terminated phone cord (straight, no twist)
- 8 Terminal block designations are for reference only. Actual boards may not be marked.

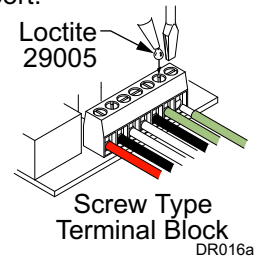

FROM		To (MOTOR #1)	To (MOTOR #2)	
AC Power Source	White	4	4	
	Black	5	5	
	Ground	7	7	
Awning #1 Motor	Black	<b>Refer to Flag Note 2</b>		
	Red			
	White			3
	Ground			6
Awning #2 Motor	Black		<b>Refer to Flag Note 2</b>	
	Red			
	White			3
	Ground			6
#1 Sensor	10' Cable	"AMD"		
#2 Sensor	10' Cable		"AMD"	
Key Pad	25' Cable	"DSK"		
RF Receiver	60" Cable	"EYE" refer to note 4		
Ignition Lockout	60" Cable	"EYE" refer to note 4		

*Phone Cord Connection*

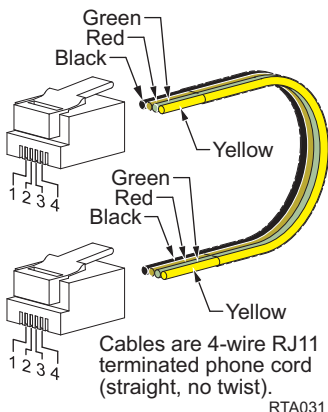

Terminated cable is a 4-wire RJ11 terminated phone cord (straight, no twist).

WIRING DIAGRAM - 4 AWNINGS

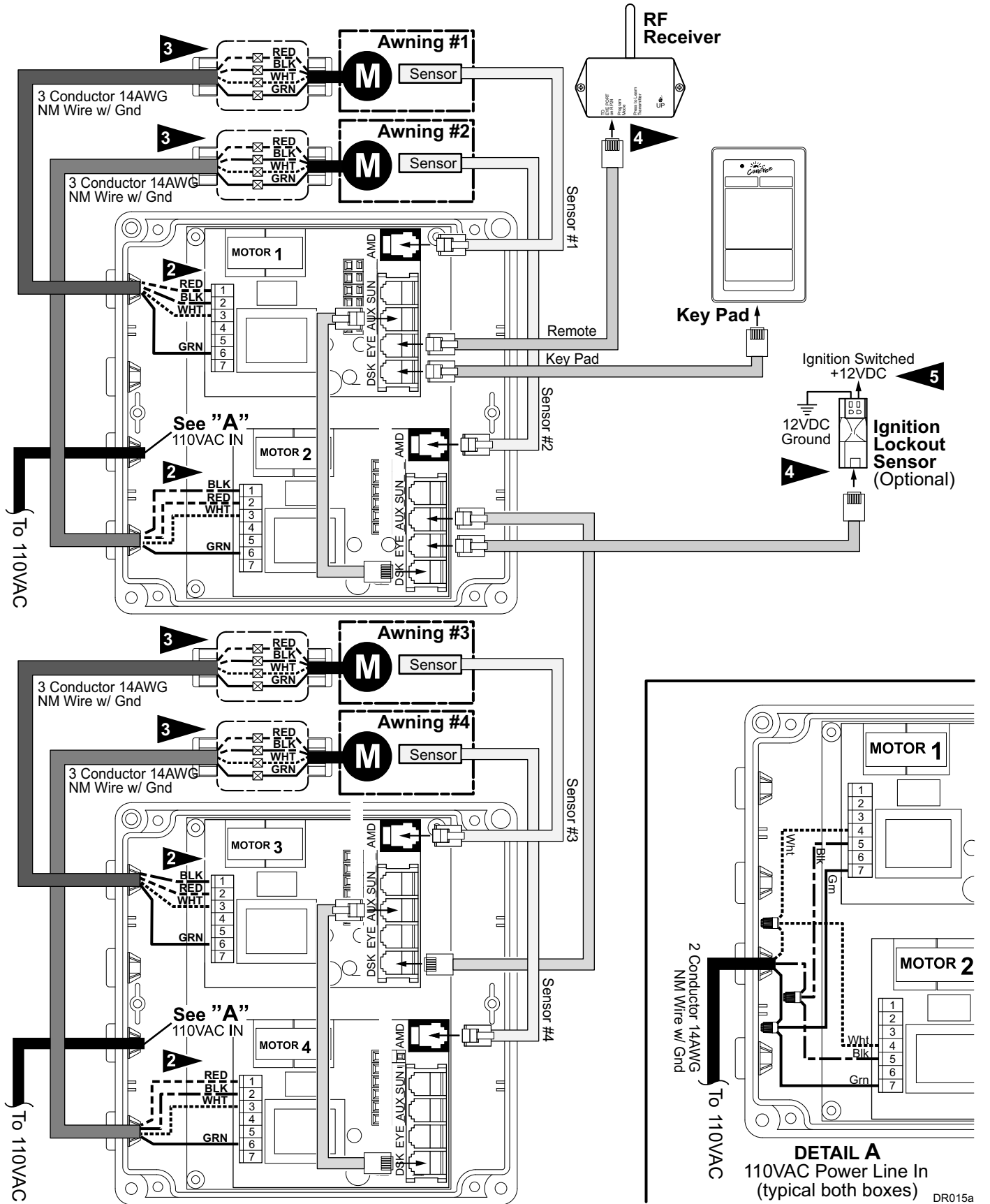

**NOTES:**

**1** Wire Legend:   
 ----- Red   
 ----- Black   
 ----- White   
 ----- Green (Ground)

**2** Awnings #1 & #4 shown as LH Motor, Awnings #2 & #3 shown as RH Motor

**For LH Motor Configurations:**

Motor Red goes to Pin (1); Motor Black goes to Pin (2)

**For RH Motor Configurations:**

Motor Red goes to Pin (2); Motor Black goes to pin (1)

**3** The SO cable from the 110VAC awning motor can only pass directly through a wall, it cannot be laid up in the wall and must be connected to NM wire or individual wires in conduit no more than 6 inches past the point of entry.

**4** The RF Receiver and the optional Ignition Lockout may be plugged into any open "EYE" port.

**5** Wires for the Ignition Lock-Out Sensor are not pin specific.

**6** For screw type terminals: After testing connections, use Loctite 29005 or equivalent to secure screws in terminal block.

**7** Cables are 4-wire RJ11 terminated phone cord (straight, no twist)

**8** Terminal block designations are for reference only. Actual boards may not be marked.

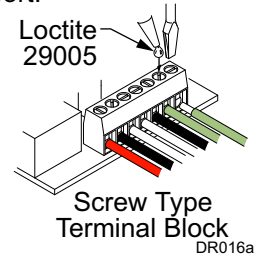

FROM		TO CONTROL BOARD				
		MOTOR #1	MOTOR #2	MOTOR #3	MOTOR #4	
AC Power Source	White	4	4	4	4	
	Black	5	5	5	5	
	Ground	7	7	7	7	
Awning #1 Motor	Black	<b>Refer to Flag Note 2</b>				
	Red					
	White					3
	Ground					6
Awning #2 Motor	Black		<b>Refer to Flag Note 2</b>			
	Red					
	White					3
	Ground					6
Awning #3 Motor	Black			<b>Refer to Flag Note 2</b>		
	Red					
	White					3
	Ground					6
Awning #4 Motor	Black				<b>Refer to Flag Note 2</b>	
	Red					
	White					3
	Ground					6
#1 Sensor	10' Cable	"AMD"				
#2 Sensor	10' Cable		"AMD"			
#3 Sensor	10' Cable			"AMD"		
#4 Sensor	10' Cable				"AMD"	
Key Pad	25' Cable	"DSK"				
RF Receiver	60" Cable	"EYE" see note 4				
Ignition Lockout	60" Cable	"EYE" see note 4				

Phone connector is shown on page 25.

### CONNECTION FLEX W/ "110VDR" CONTROL BOXES

The wiring diagrams show the standard installation for multiple awning configurations. For control boxes marked w/ "110VDR", the installer may adjust the cable interconnections for greater flexibility during installation.

1. The key pad may be installed in the unused DSK port of any board with the jumper cables sequentially connected from the AUX port to the DSK port of the next board.

*Example: Placing the keypad in the DSK of Board 3.*

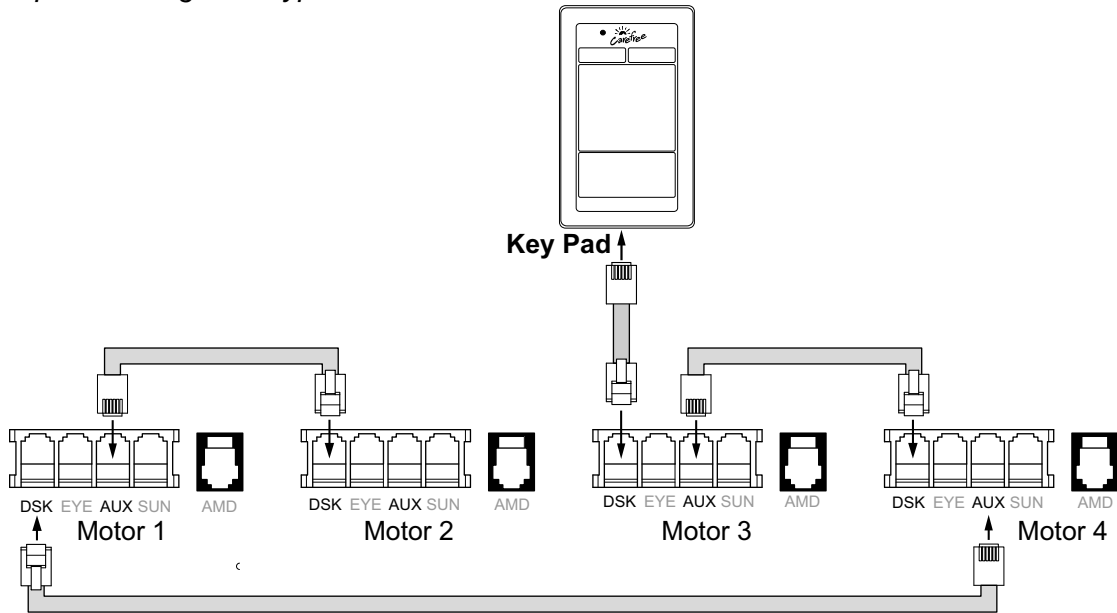

CR024

2. The RF Receiver and the optional ignition lock-out can be plugged into any unused "EYE" port.
3. The "110VDR" control boxes are compatible with integrator interfaces. Contact Carefree engineering for information and system requirements.

### OPTIONAL MANUAL BYPASS SWITCH

Installers may elect to install a manual bypass switch for testing or emergency operation of the awning. The simple switch allows the operator to extend or retract the awning without using the keypad control panel. For multiple awning installations, a separate switch must be installed for each awning.

1. Open the control box and identify the terminal block next to the phone cord jacks.
2. Connect the switch to the terminal block as shown in the diagram.

The switch is a single pole, double throw, momentary ON, center OFF. Components are installer furnished.

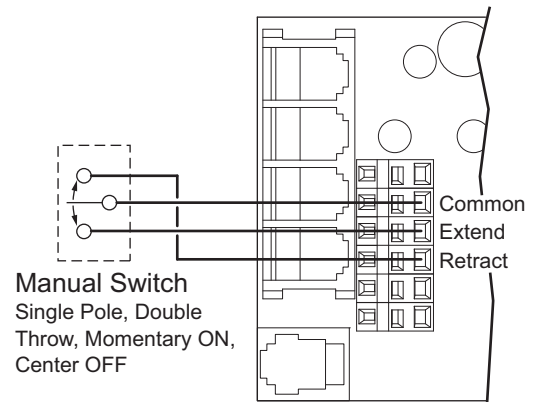

DR011

## SENSOR REPLACEMENT

The replacement sensor is furnished with a 25 foot cable. The cable is furnished in case the installed cable has been damaged or compromised.

**NOTICE** Do Not attempt to cut and splice the cable. If damaged, the cable must be replaced to ensure system integrity.

### REMOVING THE OLD SENSOR

(Detail A)

1. Remove the #10 x 3/4 screw in the mounting bracket.
2. Slide the sensor out of the bracket.

(Detail B)

3. Unscrew the wire gland from the sensor case and slide down the wire and out of the way.
4. Remove the back of the sensor case to reveal the PC board.
5. Carefully remove the board from the case. In some instances, the board may be tacked with adhesive and must be pried out. Use care to not damage the cord or connector.
6. Disconnect the cable from the board and slip the connector out of the case. Set the old sensor parts out of the way.
7. Test the integrity (continuity) of the installed cable. Several cable testers are commercially available. If the cable is faulty, go to "Replacing a Sensor and Cable". If the cable is OK go "Installing a Sensor Only".

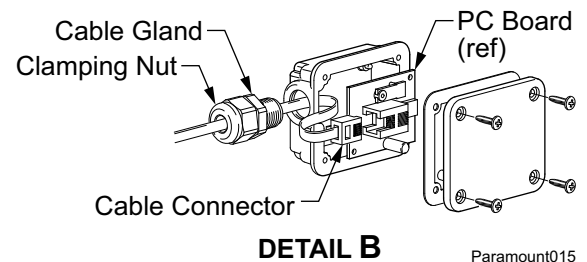
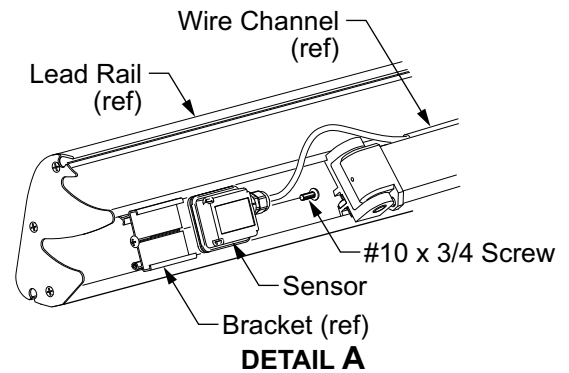

Paramount015

### REPLACING A SENSOR AND CABLE

1. Remove the existing cable. Pay particular attention to the routing and attachment points of the existing cable.
2. Slide the new sensor into the vertical mounting bracket and secure with a #10 x 3/4 screw as shown.
3. Route the new cable through the wire channel and coach to the control box. Arch the cable slightly at the arm joints to avoid binding.

*Tip: Use a small tool, such as a flat bladed screwdriver, to gently spread open the channel then insert the cable into the channel. Do this for the entire length of the channel until the cable is fully inserted.*

### INSTALLING A SENSOR ONLY:

1. On the new sensor, loosen the clamping nut on the wire gland.
2. Unscrew the wire gland from the sensor case and slide down the wire.
3. Remove the back of the sensor case to reveal the PC board.
4. Carefully remove the board from the case.
5. Disconnect the cable from the board and slip the connector out of the case.
6. Slide the connector of the existing installed cable into the new sensor case.
7. Attach the wire gland to the case. Do not tighten the clamping nut at this time.
8. Attach the cable to the new board.
9. Reassemble the new sensor.
10. Tighten the cable gland clamping nut.
11. Slide the new sensor into the vertical mounting bracket and secure with a #10 x 3/4 screw as shown.

# PART NUMBER LISTING

## SERIAL NUMBER/PART NUMBER LOCATION

Serial# / Part# Located on the Rear Outside Case on Motor Side

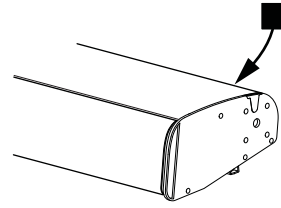

Paramount024

## ILLUSTRATED PARTS LIST



**VS Configuration**  
Canopy construction with vertical seams (previous)



**HS Configuration**  
Canopy construction with horizontal seams (current)

There are two configurations of the Paramount based on the canopy construction as shown above.

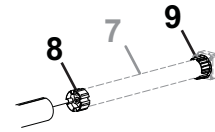

Original Motor Configuration (Silver Body)

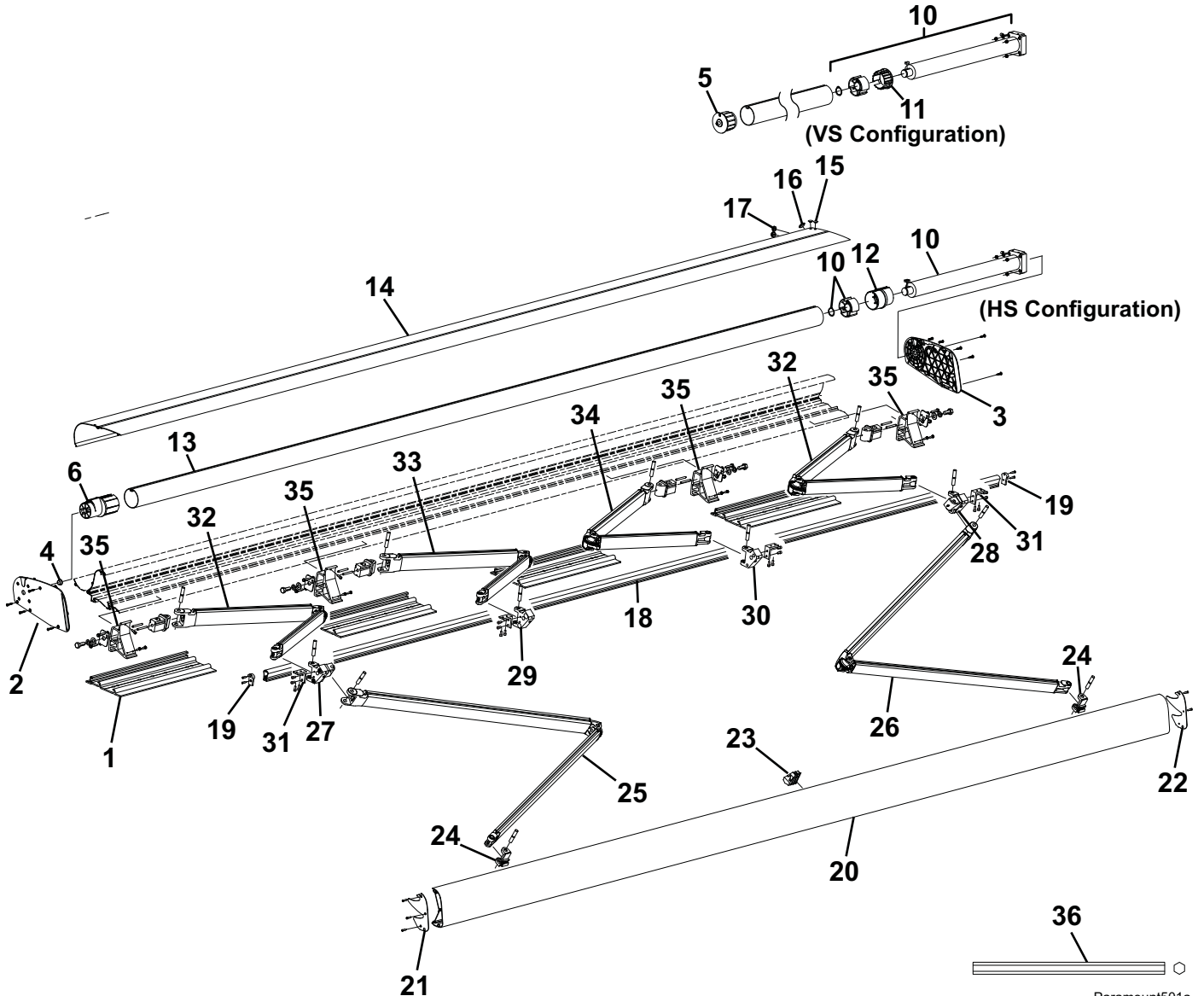

Paramount501a



Item	Part Number	Description	Notes
1	GJ001	Mounting Plate Kit, Flat	
	GJ002	Mounting Plate Kit, 3°	
2	R001376	End Plate Assy, LH, Idler	
	R001375	End Plate Assy, LH, Motor	
3	R001377	End Plate Assy, RH, Motor	
	R001378	End Plate Assy, RH, Idler	
4	R035310-002	Bushing, Idler	
5	R001054	End Plug, Idler	Used with VS Configuration
6	R041335-001	End Plug, Idler	Used with HS Configuration
7	Superseded	Motor Assy, Silver Body	Discontinued FSO R001853
8	R030886-001	Drive Gear, Motor	Used with item 9
9	R030885-001	Crown, Motor	Used with item 9
10	R001853	Motor Assy, Orange Body	5
11	R041369-001	Crown, Motor	Used with VS Configuration
12	R041336-001	Crown, Motor	Used with HS Configuration
13	R001069-xxx.xx	Roller Tube	1 7/8 Dia
14	See Note 2	Top Cover Assy	2
15	R040665-001	Plug, .375	
16	R040665-002	Plug, .75	
17	R030721-001	Grommet, 5/16 ID	
18	See Note 2	Middle Rail	2
19	R040727-106	Cover, Middle Rail	
20	See Note 2	Lead Rail	2
21	R001379	End Plate, Lead Rail, LH	
22	R001374	End Plate, Lead Rail, RH	
23	R001844	Ramp Block Kit	
24	Reference Only	Lead Rail Connector	4
25	R001380	Spring Arm, 7', LH	
26	R001381	Spring Arm, 7', RH	
27	R0141760JV	Knuckle Assy, Middle Rail, Outer LH	
28	R0141770JV	Knuckle Assy, Middle Rail, Outer RH	
29	R001382	Knuckle Assy, Middle Rail, Inner LH	
30	R001383	Knuckle Assy, Middle Rail, Inner RH	
31	R001384	L-Bracket, Middle Rail Knuckle	
32	R001609	Spring Arm, 3', Outer - 1 ea LH, 1 ea RH	3
33	R001607	Spring Arm, 3', Inner, LH	
34	R001608	Spring Arm, 3', Inner, RH	
35	R001387	Support Kit, Spring Arm	
36	030796-001	Hex Key, Manual Override	7mm
37		Canopy Only	Refer to Canopy Order Form

- Notes:
1. XXX = Color; xx = Length
  2. The Top Cover (item 2), Lead Rail (item 15) or the Middle Rail (item 16) are special order parts, contact Carefree customer service.
  3. The outer 3' arms (item 26) are replaced as a pair. Replacement kit includes 1 LH and 1 RH arm assembly.
  4. Lead rail connectors (item 18) are shown for reference only. Connectors are part of the lead rail (item 15).
  5. Motor assembly (item 10) includes drive, crown (item 11) and attaching hardware. It does not include crown (item 12).

Electronic Components

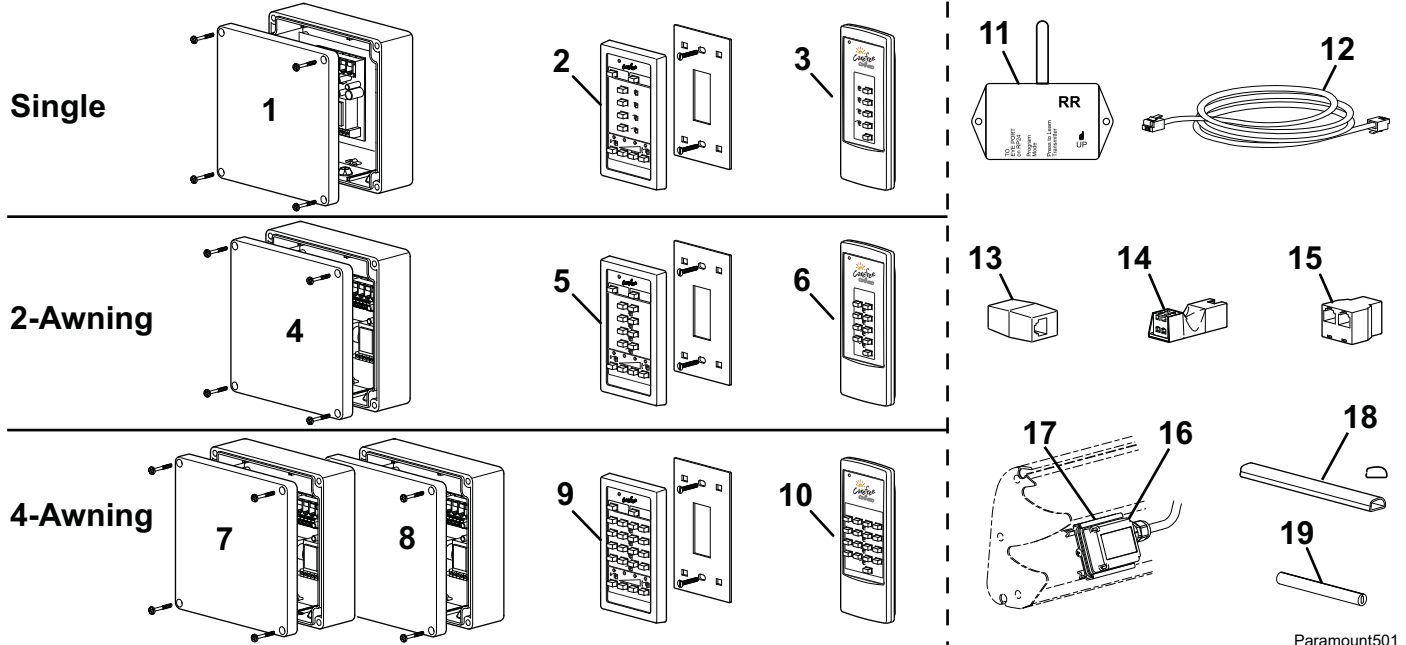

Paramount501

Item	Part Number	Description	Notes
1	R060633-001	Control Box	110VDR
2	R060618-001	Key Pad	Single Awning
3	R060624-001	Remote, 433 MHz	Single Awning
4	R060633-002	Control Box, Motor 1 & 2	110VDR
5	R060618-002	Key Pad	2-Awning
6	R060624-002	Remote, 433MHz	2-Awning
7	R060633-002	Control Box, Motor 1 & 2	110VDR
8	R060633-004	Control Box, Motor 3 & 4	110VDR
9	R060618-004	Key Pad	4-Awning
10	R060624-004	Remote, 433MHz	4-Awning
11	R060429-003	RF Remote Receiver, 433 MHz	
12	R060434-001	Phone Cable, 60"	
	R060434-008	Phone Cable, 240"	
13	R060596-001	Coupler, Cable	
14	R060532-001	Ignition Lockout Sensor, STD	
	R060532-002	Ignition Lockout Sensor, RTL, W/ Retract	
15	R060589-001	Splitter	
16	R060538-002	Motion Sensor w/ cable	
17	R001355	Bracket Kit, Vertical Sensor Mount, Apex	
18	R040616-206	Cable Channel	Black
19	R001588	Cord Retainer	16" lg

For LED replacement parts and service procedures refer to 070013-301 "LED Service Manual for Box Awnings" available on-line at [www.carefreeofcolorado.com](http://www.carefreeofcolorado.com)



