



OWNER'S MANUAL  
MIRAGE 2-STAGE

**RV**

**WITH DIRECT RESPONSE ELECTRONICS**



**Before operating the awning, carefully review the Owner's Manual. The manual contains important safety information, detailed operating instructions, common maintenance procedures and other useful information.**

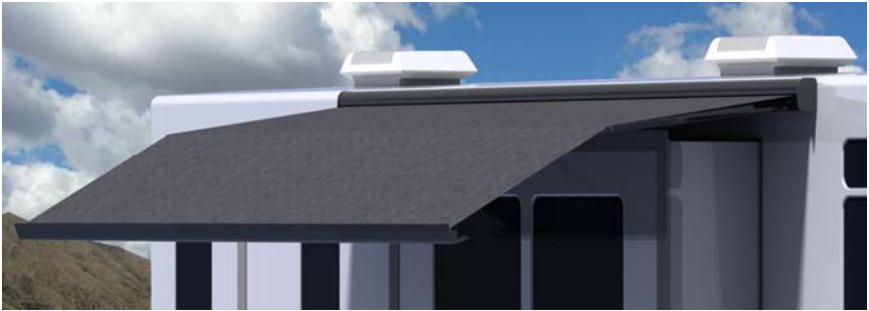

---

*TABLE OF CONTENTS*

<b>Introduction .....</b>	<b>2</b>
<b>Operation .....</b>	<b>2</b>
Warnings and Cautions .....	3
Quick Start.....	3
Single Awning Control Panel .....	4
Multiple Awning Control Panels.....	5
The Auto-Retract System .....	6
Using the Remote Control .....	7
Single Awning Key FOB .....	7
Multi-Awning Remotes .....	8
Programming the RF Receiver for a Remote .....	9
Manual Override.....	10
<b>Awning Care .....</b>	<b>11</b>
Fabric Care.....	11
Pooling .....	11
<b>Carefree Major Product Limited Warranty.....</b>	<b>12</b>

## INTRODUCTION

From its beginning in the early 70's, Carefree of Colorado has emerged as the premier manufacturer of quality awnings and accessories for Recreational Vehicles (RVs). Our full line of products can provide the accessories that match your life style; no matter what type of RV you own. Check with your dealer to discover the products that can make your life more Carefree.

---

The Mirage 2-Stage Patio Awning offers the coach owner an awning system that provides as much or as little shade as required. The versatile awning system is available as a single awning or as a 2 or 4 awning combination with all awnings controlled at a single master control panel.

Each unit is equipped with lateral support arms that are the strongest available on the market. No vertical arms interfere with coach sidewalls or equipment that may be mounted on the roof. These arms can also be adjusted to vary the canopy pitch up to 2 feet (it is strongly recommended that service and adjustments be performed by trained technicians).

The canopy is made from acrylic fabric. The canopies are housed in an aluminum case that easily blends in with the coach roof.

The unique and innovative 110V electronic control system provides Carefree's *Direct Response* system with interior pushbutton controls for standard extend/retract functions. At the master control panel the auto-retract system sensitivity can be set to respond to a variety of wind speed conditions. An RF remote is included as standard.

## OPERATION

The *Direct Response* system provides a wide range of awning controls with control panel operation in one convenient location. The standard operation is straight-forward with the buttons clearly labeled. Sensitivity control is described on page **Error!** **Bookmark not defined..**

### **Operational Notes:**

#### Ignition Lockout Sensors:

- If the optional Carefree EL ignition lockout is installed the system will disable the extend function while the vehicle ignition key is in the ON position.
- Special order RTL ignition lockouts will fully retract the awning and disable the extend function when the vehicle ignition key is in the ON position.
- Functions will return to normal operation when the ignition key is turned OFF.
- Coach manufacturers may install their own lockout design. Refer to the coach literature for AC power for accessories.

#### Awning Motor

- The awning motor is equipped with a thermal protection circuit to protect the motor from overheating. Operating the awning repeatedly over a short time period may cause the circuit to sense a overheat condition and shut off the motor. If this occurs, wait approximately 15 minutes to allow the motor to cool then operate the awning in normal fashion.

**NOTICE** **FOR MULTIPLE AWNINGS ONLY: Pressing multiple buttons at the same time may cause the awnings to appear to move erratically. If this occurs, press the stop button. Use the individual controls to set the awning(s) to the desired position.**

---

## WARNINGS AND CAUTIONS

---

**NOTICE** Awnings are designed to provide shade and protection from the sun. The effects of wind and rain on an awning are unpredictable and can cause severe damage to the awning and/or the vehicle. If wind or extended periods of rain are expected, roll up the awning.

---

**NOTICE** It is recommended that if leaving the RV unattended for a length of time, retract the awning to avoid unexpected climate conditions.

---

**WARNING** Keep all sources of heat and flame away from the awning canopy. Fabric is not fire-proof and can burn if left in contact with any flame or heat source.

---

**NOTICE** The Carefree Direct Response System is a premier electronic auto-retract system that provides protection against adverse elements; but no auto-retract system is a guarantee against severe or destructive weather; the effects of wind and rain on an awning are unpredictable and may cause severe damage to the awning and/or vehicle. If wind or extended periods of rain are expected, roll up the awning.

---

**IMPORTANT NOTE:** The auto-retract system is ON when the power is ON. The system is OFF when the power switch is set to OFF. If the power is shut off while the awning is extended, the awning is not protected by the auto-retract system.

### CALIFORNIA PROPOSITION 65

**WARNING** This product contains chemicals known to the state of California to cause cancer or birth defects or other reproductive harm. California's Proposition 65 requires this warning to be given to customers in the state of California.

---

## QUICK START

### *To Open the Awning:*

- Press the power button ON. When power is on, the Direct Response system is active and the manual controls are active. When power is OFF, all functions are disabled.
- Press and release the extend button. The awning will open completely. To interrupt the awning retraction, press the stop button. The awning will stop.

### *To Close the Awning:*

- Press and release the retract button. The awning will close completely. To interrupt the awning retraction, press the stop button. The awning will stop.
- When the awning is in the retracted (rolled up) position, press the power button OFF to avoid accidentally extending the awning.

SINGLE AWNING CONTROL PANEL

**LED Indicator**

- LED is Steady ON when power is ON.
- LED will dim and fast flash when a function key is pressed.
- LED will slow flash if a motion sensor is disengaged or disabled.

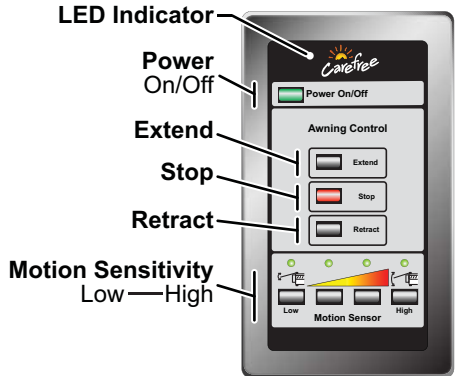

Single Awning

RTA039a

**Power**... Press ON/Press Off. The power switch must be on before any awning functions can be used. When power is ON, the LED indicator will illuminate. The Direct Response Auto-Retract is active when awning power is on.



**CAUTION** Set the power switch be to OFF whenever the awning is not being operated and during transport. This acts as a safety to prevent the awning from being accidentally opened.

**Extend**... Press and release. The awning will extend out to the full extension and stop automatically.

During normal operation, the awning will extend out completely then roll back slightly to provide tension to the fabric.

**NOTE:** If the optional Carefree ignition lockout is installed, the system disables the extend function while the vehicle ignition key is in the ON position. Functions will return to normal operation when the ignition key is turned OFF. Coach manufacturers may install their own lockout design. Refer to the coach literature for AC power for accessories.

**Stop**.... Press and release. During extend and retract functions, the operator may stop the awning by pressing this button.

**Retract**... Press and release. The awning will retract and stop automatically when the awning is fully retracted. When the button is pushed, the LED will illuminate and stay on until another function is activated.

All function buttons are press ON. The auto-functions continue until the awning is fully extended or fully retracted or when the button is pressed a second time to stop the function. It is not necessary to hold the button while the function is active.

See Page 5 for descriptions of the Auto-Retract settings.

## MULTIPLE AWNING CONTROL PANELS

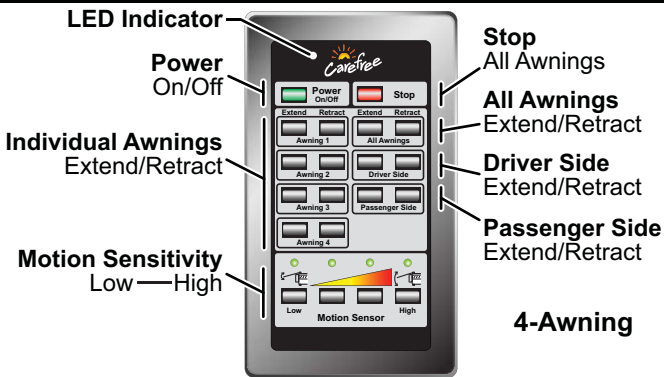
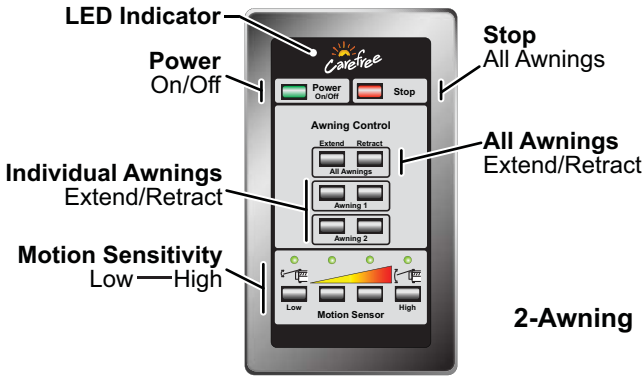

RTA039b

The controls are divided into specific groups. The individual controls allow you to extend or retract awnings individually. The combination controls can be used to simultaneously extend or retract all of the awnings.

### LED Indicator

- LED is Steady ON when power is ON.
- LED will dim and fast flash when a function key is pressed.
- LED will slow flash if a motion sensor is disengaged or otherwise disabled.

**Power**... Press ON/Press Off. The power switch must be on before any functions can be used. When the power is ON, the LED indicator will illuminate. The Direct Response Auto-Retract is active when awning power is on.



**CAUTION**

**Set the power switch to OFF whenever the awning is not being operated and during transport. This acts as a safety to prevent the awning from being accidentally opened.**

**Stop**.... Press and release. During extend and retract functions, the operator may stop the awnings by pressing this button.

**Extend**... Press and release. The awning will extend out to the full extension and stop automatically. During normal operation, the awning will extend out completely then roll back slightly to provide tension to the fabric.

**Retract**... Press and release. The awning will retract and stop automatically when the awning is fully retracted.

## Carefree of Colorado

**To stop an individual awning during an operation**, press and release the SAME button a second time. Example press the extend button to extend the first awning, press the same extend button to stop the first awning before the awning is fully extended. THIS DOES NOT APPLY TO THE EXTEND ALL OR RETRACT ALL BUTTONS!

**IMPORTANT NOTE:** When using the "Extend All" or "Retract All" commands, the awnings continue until FULLY extended or retracted. To stop the awnings, press the stop button.

### THE AUTO-RETRACT SYSTEM

The system is active when the awning power is on and disabled when the power is shut off. To turn on the system, press the power button ON.

The *Direct Response* system detects awning motion caused by windy conditions. The motion sensor is located in the lead rail. The system operates by gauging the vertical motion of the awning's leading edge. When persistent motion exceeds the factory preset, the system retracts the awning. The control panel provides 4 factory preset sensitivity values (threshold values). You may have to experiment to find the best setting for your preferences.

**Low**..... The lower the selection, less motion is required before the system closes automatically.

**High**..... The higher the selection, more motion is required before the system closes automatically.

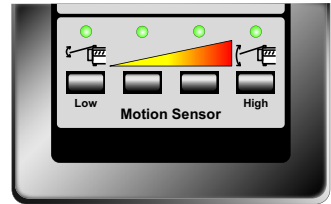

RTA039c

**IMPORTANT NOTE FOR MULTIPLE AWNING CONFIGURATIONS:** Each awning has an independent motion sensor. During windy conditions, the awnings may not retract concurrently.

**NOTE:** If the Indicator LED flashes (slow pulse), this indicates that a motion sensor has been disengaged or otherwise disabled; the affected awning(s) are not protected by the auto-retract system. The awning must be retracted using the command buttons. Immediately contact a Carefree service center for service.

## USING THE REMOTE CONTROL

A remote control is provided with the *Direct Response* system. In simple terms, the remote is a wireless key pad that functions in the same manner that the stationary control panel. The remote provides the advantage of allowing you to operate the awning from any convenient location.

The remote has a maximum operating range of 50 feet. Actual distance may vary depending on the specific installation and location of the receiver in the vehicle.

Remotes transmit on a frequency of 433MHz.

To use: turn system power ON at the control panel.

**NOTE:** Power ON/OFF and the Auto-Retract system can only be operated at the control panel.

### SINGLE AWNING KEY FOB

A remote control Key FOB is furnished with the single awning installation. To use: turn system power ON.

**Extend**..... Press and release. The awning will extend out to the full extension and stop automatically.

**Retract**..... Press and release. The awning will retract and stop automatically when the awning is fully retracted.

**Stop**..... Press and release. During extend and retract functions, the awning may be stopped by pressing this button.

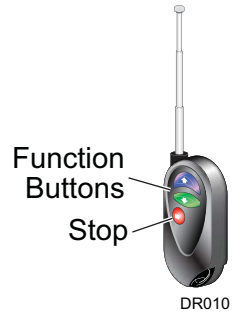

### Key FOB Battery

The 433 MHz remote uses a battery (Radio Shack p/n 23-279 or equivalent) that should provide a long period of service. To access: Remove the small screw from the back of the case and carefully snap off the back. Lift the old battery out and insert the new battery.

Batteries are available through your local battery outlets.

Battery life is dependent on frequency of use, environmental conditions and condition of remote.

MULTI-AWNING REMOTES

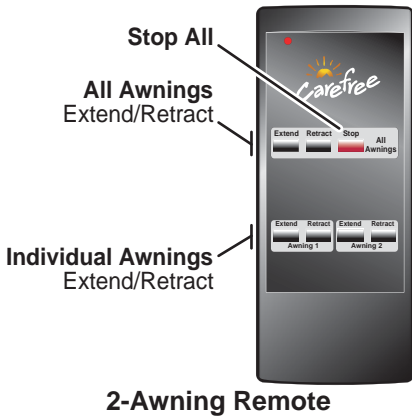

**Extend**..... Press and release. The awning will extend out to the full extension and stop automatically. During normal operation, the awning will extend out completely then roll back slightly to provide tension to the fabric.

**Retract**..... Press and release. The awning will retract and stop automatically when the awning is fully retracted.

**Stop**..... Press and release. During extend and retract functions, the operator may stop the awnings by pressing this button.

**To stop an individual awning during an operation**, press and release the SAME button a second time. Example press the extend button to extend the awning, press the same extend button to stop the awning before the awning is fully extended. THIS DOES NOT APPLY TO THE EXTEND/RETRACT ALL BUTTONS!

**IMPORTANT NOTE:** When using the "Extend All" or "Retract All" commands, the awnings continue until FULLY extended or retracted. To stop the awnings, press the stop button.

**Key Pad Remote Battery**

The remote uses two standard AAA Batteries that should provide a long period of service. To access: open the access cover on the back of the case. Batteries are available through your local battery outlets.



*PROGRAMMING THE RF RECEIVER FOR A REMOTE*

When adding or replacing a remote control, it is necessary to program the transmitter and receiver.

1. Power to the control box must be on.
2. Locate the receiver box.
3. Press and release the "Press to Learn Transmitter" button on the bottom of the receiver. The receiver is in program mode when the red light comes on.
4. For Single Awning Key FOBS: Press and release the STOP button on the remote. The red light will go out after the receiver learns the remote signal.

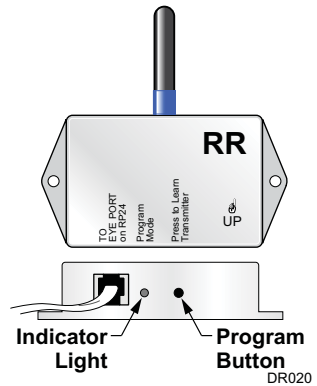

**NOTE:** Pressing the stop button will cause the blue up arrow button to default as the open (extend) function.

If a function button is pressed to train the receiver, it will be programmed as the open (extend) button. Example: Pressing the bottom button will program the bottom button for extend and the top button as retract.

5. For Multiple Awning Remotes: Press and release the ANY button on the remote. It is recommended to use the STOP button. The red light will go out after the receiver learns the remote signal.



**CAUTION** When the receiver learns the transmitter signal, the system will perform the operation of the button pressed. Example: Pressing an "Extend" button during the learning phase will cause the awning to extend when the receiver learns the signal. Use caution to avoid unexpected movement by the awning.

6. Repeat for each additional remote.

**OPERATIONAL NOTES:**

- The transmitter and receiver operate on a frequency of 433MHz.
- The receiver exits the program mode after ten seconds.
- If the light does not come on in step 2, the memory is full and must be cleared. If the light still does not come on, check the continuity of the cord between the boxes and repair or replace as required. Pin 1 of the 1<sup>st</sup> connector goes to pin 1 of the 2<sup>nd</sup> connector etc.
- If the light does not go out above, the receiver knows the transmitter signal or the battery in the Remote needs to be replaced.
- To clear the memory: PRESS AND HOLD the receiver learn button. While holding the button, the indicator light should be OFF for the full 5 seconds then come on.
- The receiver may be programmed for up to 5 remotes. Additional remotes may be ordered separately.

## MANUAL OVERRIDE

If 110V power is not available to the coach, the Mirage awning can still be safely retracted using the manual override. The bypass may be accessed from inside the case on the motor housing or from the top of the case above the motor housing.

*To use the top bypass access:* Remove the screw and well nut that is used to secure the end cap.

*To use the inside bottom access:* The awning must be open 6- 8" to afford access to the override.

1. Chuck the supplied 7mm hex key into a 3/8" battery powered drill.
2. Insert the hex key into the manual override on the awning. For the top access, it will be necessary to locate the hex by feel; it is not visible with the key inserted in the hole.
3. Operate the drill in the forward (clockwise) direction to close the awning. Reverse the drill to open the awning.

**NOTE:** When using the bottom override, the awning can only be closed within 6-8". It will be necessary to use the top access to close the awning completely.

4. When done, return the screw and well nut to the top of the case if removed.

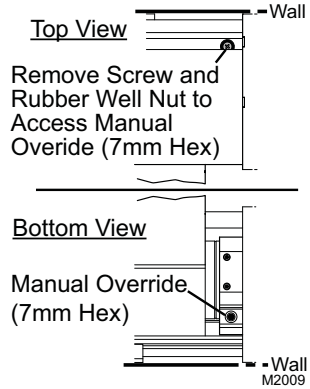

## AWNING CARE

Maintaining a Carefree Awning is easy. Just follow these basic steps:

- Always operate the awning according to the instructions.
- Periodically check that the fasteners are tight. Tighten if necessary.
- Keep the awning fabric and arms clean.

### *FABRIC CARE*

**NOTICE** Do not use oil based cleaners or any caustic, granulated, or abrasive type cleaners on your Carefree product.

1. One of the best ways to keep the fabric looking good and to delay the need for deep or vigorous cleanings is to hose fabrics off on a monthly basis with clear water. This practice will help prevent dirt from becoming deeply imbedded in the fabric. In most environments, a thorough cleaning will be needed every two to three years.
2. When it's time for a thorough cleaning, the fabric can be cleaned while still on the awning frame.
  - For Acrylic Fabric – Use a stiff brush and warm water with soap.
3. When cleaning the fabric, it is important to observe the following:
  - Always use a natural soap, never detergent.
  - Water should be cold to lukewarm, never more than 100°F.
  - Air-dry only. Never apply heat to the fabric.
  - Always allow the fabric to dry thoroughly before retracting the awning.

### *POOLING*

When water collects on the top of the fabric, this is known as "pooling". This can occur during inclement weather or if a running air conditioner discharges over the awning. The water is dumped when the awning is retracted. It is recommended that if water accumulates on the top; retract the awning in steps (8"-12") to dump the water. This will help prevent the fabric from stretching or distorting.

**The effects of wind and rain on an awning are unpredictable. Severe damage to the awning and the vehicle may result. IF WIND OR EXTENDED PERIODS OF RAIN ARE EXPECTED, RETRACT THE AWNING AND SECURE.**

# CAREFREE MAJOR PRODUCT LIMITED WARRANTY

Carefree of Colorado (hereafter referred to as Carefree) warrants to the first retail Purchaser that the Carefree Product is free of defects in material and workmanship within the terms and conditions as set forth in the warranty statement available online at [www.carefreeofcolorado.com](http://www.carefreeofcolorado.com). Carefree's obligation under this warranty is limited to the repair or replacement, at Carefree's option, of any defective component with new or factory refurbished components.

OWNER MUST RETAIN THE ORIGINAL PROOF OF PURCHASE AND/OR HAVE THE PRODUCT WARRANTY REGISTRATION ON FILE AT CAREFREE FOR WARRANTY CLAIMS.

THIS WARRANTY IS NOT TRANSFERABLE.

**For**

- **Warranty Duration;**
- **Warranty Coverage and Exclusions;**
- **Warranty Terms of Coverage; and,**
- **Warranty Claim Procedures**

Refer to publication  
"Carefree Major Product Limited Warranty"  
available online at

[www.carefreeofcolorado.com](http://www.carefreeofcolorado.com)

**Register your Carefree products on-line at [www.carefreeofcolorado.com](http://www.carefreeofcolorado.com)**

---

*Publications available on-line @ [www.carefreeofcolorado.com](http://www.carefreeofcolorado.com):*

**052588-001 Mirage 2-Stage Installation Manual**

**052588-201 Mirage 2-Stage Owner's Manual**

**IMPORTANT NOTICE:** It is strongly recommended that adjustments and repairs not described in this book be performed by trained technicians at your Authorized Carefree Dealer. Work performed by non-authorized persons or businesses may void warranty.



Electric components in this product have been tested by the following agencies:



**Motor:** **UL Recognized (USA & Canada)**

**Controls:** **UL Listed (USA & Canada)**