



RV

with Direct Response Electronics



Read this manual before installing or servicing this product. Failure to follow the instructions and safety precautions in this manual can result in personal injury and/or cause the product to not operate properly.



TABLE OF CONTENTS

Product Overview 1

 Apex Patio Awning Specifications 1

 Component Checklist..... 2

Installation – Mechanical 4

 Required Pre-Installation Parameters..... 4

 Mounting Plate Layout and Installation..... 4

 Mounting the Awning Unit..... 5

Installation – Electrical..... 6

 Control Panel Installation - Key Pad 6

 Control Box Installation..... 7

 Installing the Remote Receiver..... 8

 Programming the Remote Receiver 8

 Operational Notes: 8

 Ignition Lockout Sensor Installation (Optional)..... 9

 Wiring Diagram – Single Awning 10

 Wiring Diagram – 2-Awnings 11

 Wiring Diagram – 4 Awnings 13

 Connection Flex w/ "110VDR" Control Boxes 15

 Optional Manual Bypass Switch 15

 Optional LED Lighting Switch Installation 16

Standard System Adjustments 17

 Adjusting the Pitch..... 17

 Setting the Motor Limits..... 18

 Adjusting the OUT Limit Switch 18

 Adjusting the IN Limit Switch 18

 Manual Override 19

PROPRIETARY STATEMENT

The Apex Patio Awning is a product of Carefree of Colorado, located in Broomfield, Colorado, USA. The information contained in or disclosed in this document is considered proprietary to Carefree of Colorado. Every effort has been made to ensure that the information presented in the document is accurate and complete. However, Carefree of Colorado assumes no liability for errors or for any damages that result from the use of this document.

The information contained in this manual pertains to the current configuration of the models listed on the title page. Earlier model configurations may differ from the information given. Carefree of Colorado reserves the right to cancel, change, alter or add any parts and assemblies, described in this manual, without prior notice.

Carefree of Colorado agrees to allow the reproduction of this document for use with Carefree of Colorado products only. Any other reproduction or translation of this document in whole or part is strictly prohibited without prior written approval from Carefree of Colorado.

SAFETY INFORMATION



This is the safety alert symbol. It is used to alert individuals to potential personal injury hazards. Obey all safety messages that follow this symbol to avoid possible personal injury or death.



Indicates a hazardous situation, which if not avoided, could result in death or serious bodily injury.



Indicates a hazardous situation, which if not avoided, may result in minor or moderate bodily injury.



Indicates a situation that may result in equipment-related damage.

General Safety:



This product can expose you to chemicals including Di-isodecyl phthalate (DIDP), Vinyl Chloride and Formaldehyde, which are known to the state of California to cause cancer or birth defects or other reproductive harm. For more information visit www.P65warnings.ca.gov



Shock Hazard. Always disconnect battery or power source before working on or around the electrical system.



Always wear appropriate safety equipment (i.e. goggles).



Always use appropriate lifting devices and/or helpers when lifting or holding heavy objects.



When using fasteners, do not over tighten. Soft materials such as fiberglass and aluminum can be "stripped out" and lose the ability to grip and hold.

Electric components in this product have been tested by the following agencies:



Motor: UL Recognized (USA)
CSA Approved (Canada)

Controls: UL Listed (USA & Canada)



PRODUCT OVERVIEW

The Apex Patio Awning offers the coach owner an awning system that provides as much or as little shade as required. The canopies are housed in an aluminum case that easily blends in with the coach roof. The awning extends to a maximum of 10 feet from the side wall. The canopy is made from Acrylic fabric.

Each unit is equipped with lateral support arms that are the strongest available on the market. No vertical arms interfere with coach sidewalls or equipment that may be mounted on the roof. These arms can also be adjusted to vary the canopy pitch up to 3 feet (it is strongly recommended that service and adjustments be performed by trained technicians).

The unique and innovative 110V electronic control system provides Carefree's *Direct Response* system with interior touch pad controls for standard extend/retract functions. At the master control panel the auto-retract system can be engaged to automatically retract the awnings in windy conditions with sensitivity, set by the user, to respond to a variety of wind speed conditions. An RF remote is furnished with the *Direct Response* system.

Apex Patio Awning Specifications

The following information is for reference only. Specific information is detailed in the installation instructions.

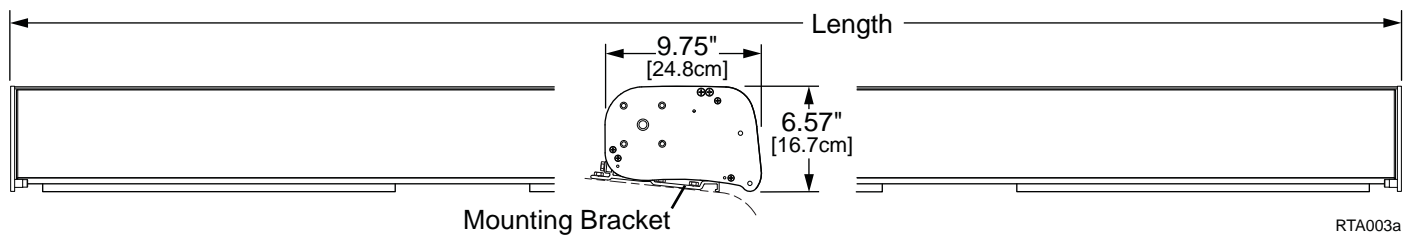

LENGTHS:	11' 6" – 21'	
EXTENSIONS:	10' (standard)	
COLORS AVAILABLE:	Case:	Black
	Fabric:	Woven Acrylic Fabric refer to order form for available colors
MOTOR SPECIFICATIONS:	Available in LH or RH configurations	
Type:	Tubular Motor	
Power:	120V, 60HZ, 2.5A	
Torque:	60 nm	
Speed:	14 RPM	
Cycle:	40 Sec ON / 1 Min OFF	

APPROXIMATE WEIGHT (LBS.)					
Awning Length (ft.)	Weight	Awning Length (ft.)	Weight	Awning Length (ft.)	Weight
12	155	16	192	20	227
13	162	17	198	21	234
14	169	18	205		
15	185	19	216		

COMPONENT CHECKLIST

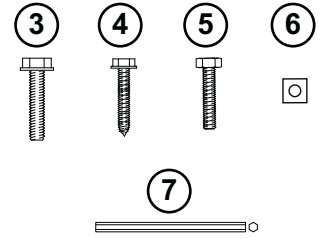
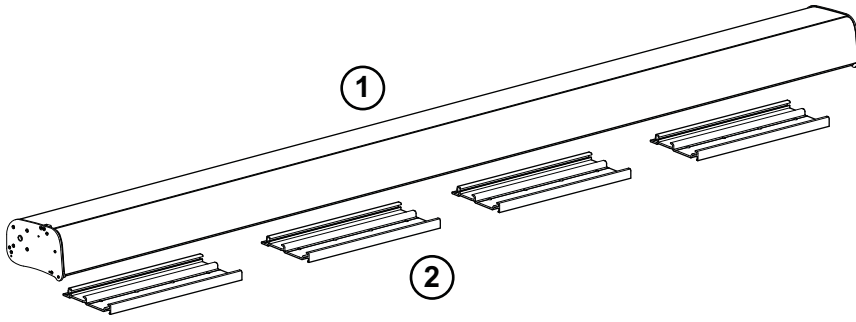

Single Awning

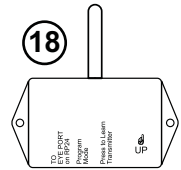
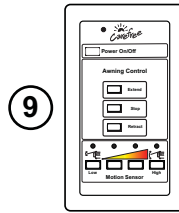
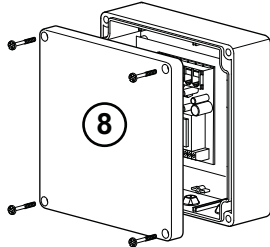

Dual Awning

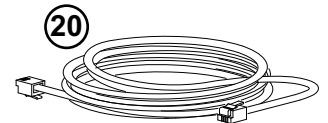
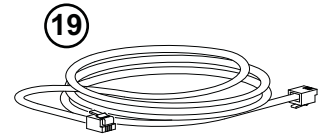
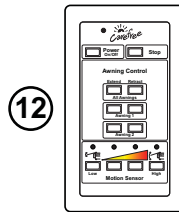
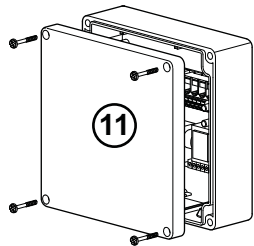

4-Awning

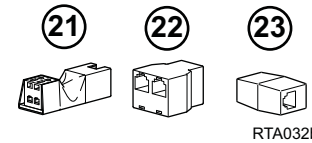
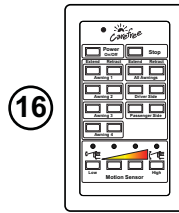
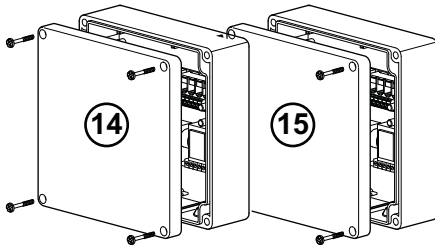

<input checked="" type="checkbox"/>	ITEM	DESCRIPTION		QTY	NOTE
<input type="checkbox"/>	1	Apex Awning Assembly		1	1
<input type="checkbox"/>	2	Mounting Bracket		(Note)	2
<input type="checkbox"/>	3	Screw, Rolock, Thread Cutting	3/8 x 1 1/2	(Note)	3
<input type="checkbox"/>	4	Screw, Lag	3/8 x 3	(Note)	3
<input type="checkbox"/>	5	Screw, Hex Head	5/16-18 x 2	(Note)	3
<input type="checkbox"/>	6	Square Nut	5/16-18	(Note)	3
<input type="checkbox"/>	7	Hex Key	7mm x 133mm	1	
<input type="checkbox"/>	8	Control Box	Single Awning	1	4
<input type="checkbox"/>	9	Key Pad Assy	Single Awning	1	4,5
<input type="checkbox"/>	10	Remote Control Key FOB, 433MHz	Single Awning	1	6
<input type="checkbox"/>	11	Control Box	Dual Awning	1	4
<input type="checkbox"/>	12	Key Pad	Dual Awning	1	4,5
<input type="checkbox"/>	13	Remote w/ stop, 433 MHz	Dual Awning	1	4,6
<input type="checkbox"/>	14	Control Box 1 (Motor #1, Motor #2)	4-Awning Combo	1	4
<input type="checkbox"/>	15	Control Box 2 (Motor #3, Motor #4)	4-Awning Combo	1	4
<input type="checkbox"/>	16	Key Pad	4-Awning Combo	1	4,5
<input type="checkbox"/>	17	Remote w/ stop, 433 MHz	4-Awning Combo	1	4,6
<input type="checkbox"/>	18	RF Receiver, 433 MHz		1	
<input type="checkbox"/>	19	RJ11 Cable	60 inches	1	7
<input type="checkbox"/>	20	RJ11 Cable	240 inches	1	9
<input type="checkbox"/>	21	Sensor, Ignition Lock-Out		1	7,8
<input type="checkbox"/>	22	Splitter		1	7,8
<input type="checkbox"/>	23	Coupler, Cable		1	9

- Notes:
1. Awning configuration is specified at time of order, including awning length, LH or RH configuration, fabric color etc. Check awning assembly against original purchase order.
 2. Item 2 Mounting Plates: Quantity of 3 per awning 18'-11" or less
Quantity of 4 per awning 19' or longer
Some Original Equipment Manufacturer (OEM) installations may specify a different quantity.
 3. Mounting screws (item 3 or 4) for the mounting plates = 6 per mounting plate
Securing screw (item 5) and nut (item 6) = 1 each per mounting plate. See note 2.
 4. Electronic components are not interchangeable between systems.
 5. Mounting screws are included with switches and mounting plates.
 6. Additional remotes can be ordered separately.
 7. 60" cable (item 19) is furnished with items 9a, 18 and 21, one additional cable is furnished with the 4-awning control boxes (items 14, 15).
 8. The optional ignition lockout and splitter (items 21, 22) must be ordered separately. Two versions of the lockout sensor are available; refer to page 9 for description.
 9. Long cable (item 20) and /or coupler (item 23) are specified at time of order.

INSTALLATION – MECHANICAL

The following instructions are for the physical installation of one Apex awning. Repeat the instructions for each awning to be installed.

REQUIRED PRE-INSTALLATION PARAMETERS

Prior to installing the awning system, the installer must determine the layout of the system and provide specific construction elements to successfully assemble the awning components.

- Determine the location, size and type of awning to be mounted.
 - There must be structure at the awning mount locations. Fiberglass or sheet metal alone is **NOT** strong enough to support the weight of the awning!

⚠ WARNING The Apex awning has significant weight. The awning and attaching brackets must be securely attached to the structural frame of the roof. Consult the coach manufacturer to determine the type and position of the roof's structural members and the structure's ability to support the weight. Failure to heed this warning can result in serious injury and property damage

- Determine the mounting locations for the control box and switch assemblies.
 - For 110VAC installations, the installer must provide enclosed junction boxes for all wire splices. Boxes are required in conformance with prevailing construction codes.
 - At the control box location, AC input is required. It is recommended that the installer provide a dedicated AC circuit for the awning system that is protected by an appropriate sized fuse/circuit breaker. Each patio awning draws a maximum of 3 amps.
 - The motion sensor for the *Direct Response* system is mounted on the lead rail of the patio awning. 10 feet cable is available from the awning mount position, and will require a routing path to the control box. If the control box is located at a distance greater than 10 feet, the installer must provide a terminated jumper cable from the box location to the cable end.



⚠ CAUTION The Apex awning is extremely heavy. Moving and/or lifting the awning requires a minimum of 3 people. The use of a lifting device is strongly recommended.

MOUNTING PLATE LAYOUT AND INSTALLATION

Below is the mounting pattern using four (4) 22" mounting brackets. For units using only three (3) brackets, locate the two outer brackets per the chart; center the third bracket between the outer brackets.

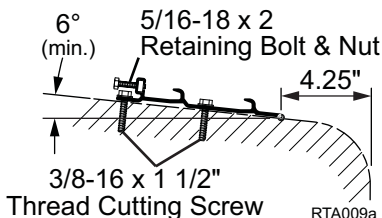
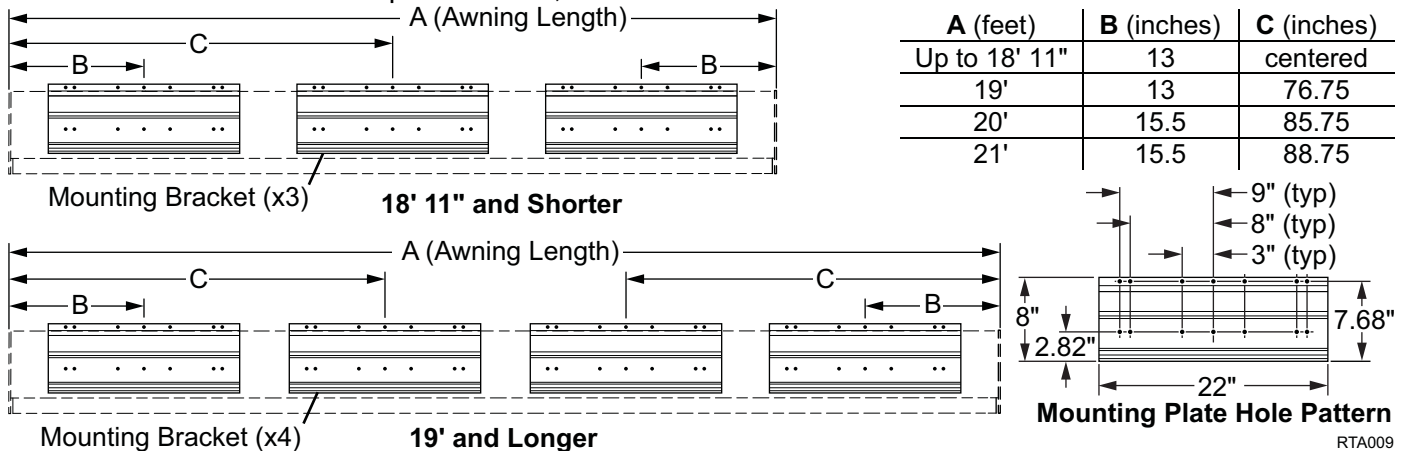

NOTE: For proper operation the mounting plate must be mounted a minimum 6° to the ground. If the roof is not at the minimum angle, the installer must furnish a mounting wedge under the mounting plate to achieve the correct angle.

1. Determine the location of the awning mounts:
 - 1.1 Mounting area must be flat and clear of obstacles,
 - 1.2 The awnings have appreciable weight; the mounting screws MUST fasten into the structure.
2. Position the mounting plates on the coach roof. Horizontally position the plates using the dimensions in the chart.

NOTE: Two types of attaching screws are included in the kit. The 3/8" rolock screws are for attaching into metal structure. The 3/8" lag screws should be used for attaching into wood structures.
3. *For rolock thread cutting screws:*
 - 3.1 For each plate, on one end of the plate, use the plate as a template and drill an 11/32" pilot hole into the structure. Attach the plate using a 3/8-16 x 1 1/2 thread cutting screw.
 - 3.2 Confirm position of plate and repeat step 6 on the opposite end of the mounting plate.
 - 3.3 Continue to drill and attach using the 3/8-16 x 1 1/2 thread cutting screws. Use six (6) screws minimum per plate.
4. *For lag screws:*
 - 4.1 For each plate, on one end of the plate, use the plate as a template and drill a 3/16" pilot hole into the structure. Attach the plate using a 3/8 x 3 lag screw.
 - 4.2 Confirm position of plate and repeat step 6 on the opposite end of the mounting plate.
 - 4.3 Continue to drill and attach using the 3/8 x 3 lag screws. Use six (6) screws minimum per plate.
5. In the rear track of each mounting plate, start one (1) 5/16-18 x 2 screw and square nut through hole in back of mounting plate. Do not tighten at this time.
6. At the motor location, drill one (1) 1/2" hole through outer surface. The position may be under or behind the end cap position.

MOUNTING THE AWNING UNIT

1. While lifting the awning, route the awning motor wires through the 1/2" hole drilled previously.

NOTE: It is necessary to first insert the sensor cable and connector through the hole then insert the motor wires.
2. Set the awning into the hooks of the mounting bracket. Pull the case forward to fully engage the bracket.
3. Adjust the horizontal position of the awning as required.
4. Tighten the securing bolts. Torque to 10 ft-lbs.
5. Seal the wires and access hole with a quality silicone sealant.

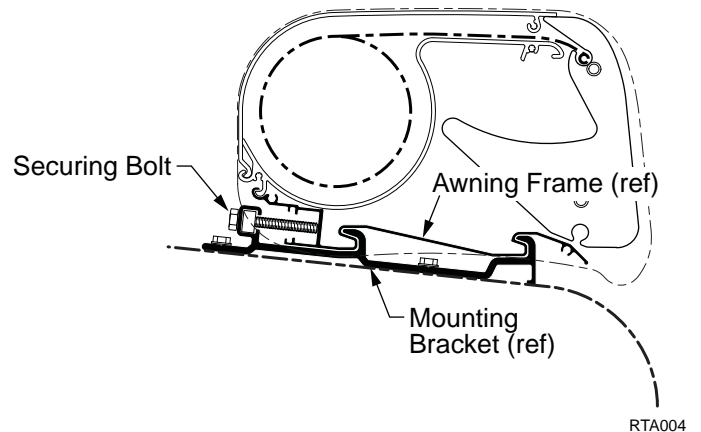

INSTALLATION – ELECTRICAL



! WARNING Shock Hazard. Always disconnect battery or power source before working on or around the electrical system.

IMPORTANT NOTICES:

- Failure to follow the wiring instructions in this publication may void the warranty.
- All wiring must conform to NEC (National Electrical Code) and local codes.
- Do NOT wire two or more motors to one motor controller.
- The SO cable from the 110VAC awning motor can only pass directly through a wall, it can not be laid up in the wall and must be connected to NM wire or individual wires in conduit no more than 6 inches past the point of entry.
- The installer must provide enclosed junction boxes for all 110VAC wire splices. Boxes are required in conformance with prevailing construction codes. Installers are required to furnish the UL approved electrical boxes where required.
- At the control box location, AC input is required. It is recommended that the installer provide a dedicated AC circuit for the awning system that is protected by an appropriate sized fuse/circuit breaker. Each patio awning draws a maximum of 3 amps.
- The motion sensor for the *Direct Response* system is mounted on the patio awning. 10 feet cable is available from the awning wall mount, and will require a routing path to the control box. If the control box is located at a distance greater than 10 feet, the installer must provide a terminated jumper cable from the box location to the cable end.
- Terminated cable is a 4-wire RJ11 terminated phone cord (straight, no twist).

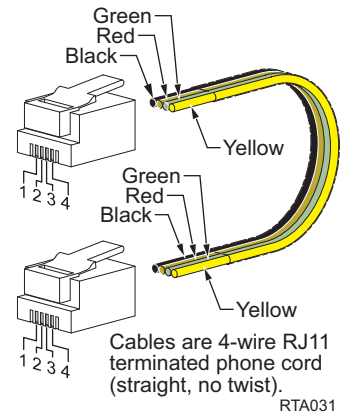

NOTE: Cable lengths of the furnished cables are listed in the chart with the system wiring diagram. If a connection requires a length greater than the supplied cable, the installer must provide a terminated jumper cable from the box location to the cable end. Terminated cables are 4-wire RJ11 terminated phone cord (straight, no twist).

KEY PAD INSTALLATION

1. Locate the mounting location of the key pad. The key pad requires a flat area approximately 2 3/4" wide by 4 1/2" tall.
2. Use the mounting plate as a template and mark the location of the two mounting holes.
3. Remove the plate, mark and cut a 1" hole in the position shown.
4. Mount the plate to the surface using the included screws.
5. Route the 25 foot RJ11 cable from the control box location through the wall and mounting plate.
6. Attach the cable to the back of the key pad then attach the key pad to the mounting plate.

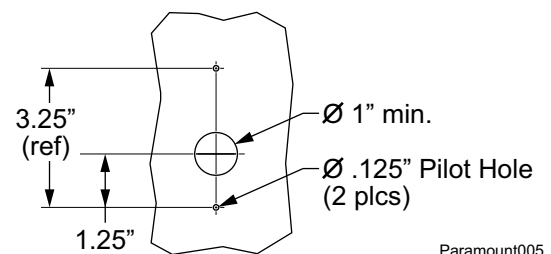
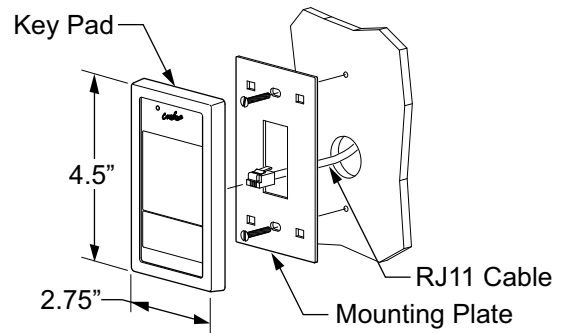

Paramount005

CONTROL BOX INSTALLATION

NOTES:

- For Multiple Awning Installations:* The awning motor that is connected to the controller board marked "motor #1" will correspond with "Awning 1" on the touch pad control and remote. The awning motor connected to "motor #2" will correspond with "Awning 2" on the controls etc.
- For 4-Awning Installations:* Awnings connected to motor #1 & #2 correspond to "Passenger Side Awnings", awnings connected to motor #3 & #4 correspond to "Driver Side Awnings".
- The control boxes are not suitable for exterior installations and must be mounted in the INTERIOR of the vehicle.

For Single Awning installations: refer to wiring diagram on page 10.

For 2-Awning installations: refer to wiring diagram on page 11.

For 4-Awning installations: refer to wiring diagram on page 13.

- Locate the mounting location of the control box(es). Each box requires a flat area approximately 6 1/2" x 6 1/2" with a clearance depth of 2 3/8".

For 4 awning installations: A 60" jumper cable is used between the two control boxes. This allows approximately 55" of cable between the boxes. Position the boxes to allow the jumper to be connected and routed with some slack in the cable.

- Remove the lid. Attach the box to the mounting surface using a minimum of two (2) #8 x 3/4 screws each. The screws must be mounted in opposite corners.
- Route a 2-conductor 14AWG NM wire w/ ground from the AC power source to the box. It is recommended that the installer provide a dedicated AC circuit that is protected by an appropriate sized fuse/circuit breaker. Each patio awning draws a maximum of 3 amps.
- Connect the wires to the control box circuit boards as shown in the wiring diagram (Detail A).
- Route the motor wires from awning #1 to controller #1 (motor#1); attach the wires to the terminals as shown.

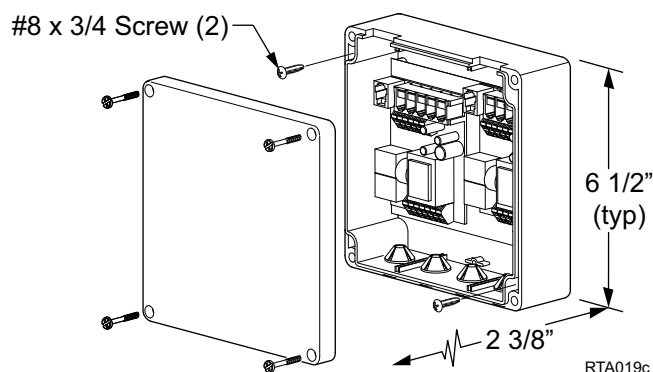
**NOTE: For LH motor configurations:**

RED WIRE goes to terminal (1);

BLACK WIRE goes to terminal (2).

For RH motor configurations:

RED WIRE goes to terminal (2);

BLACK WIRE goes to terminal (1).

- Attach the RJ11 cable from the sensor of awning #1 to the "AMD" receptacle of controller #1.
- Repeat step 5 and 6 for the other awnings.
- After testing connections, use Loctite 29005 or equivalent to secure screws in terminal block.
- Attach the remaining RJ11 cables as shown in the wiring diagram. Use the slot cutouts in the box to route the phone cables.

NOTE: The key pad and RF receiver only attach to controller #1.

INSTALLING THE REMOTE RECEIVER

1. Determine the location of the RF receiver:
 - 1.1 Do not mount the unit near heat producing elements such as LP appliances or engine exhaust components.
 - 1.2 For best reception, do not mount the unit near or on a metal surface.
 - 1.3 Mount the unit with the antenna pointing up.
 - 1.4 The included cable is approximately 60 inches long. Mount the unit close enough to the splitter or control box so that the cord can be connected without stressing the connections.
 - 1.5 Allow adequate room below the box to access the connector jack, programming button and indicator light.

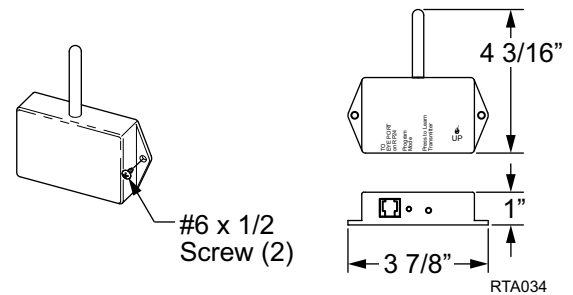

2. Position the control box and secure using two (2) #6 x 1/2" screws.

NOTE: If the box is mounted on a surface that is less than 1/2" thick, the screws will protrude through the opposite side of the surface.
3. Connect the cable to the receiver.
4. Route the cable to the splitter; or, to the control box and connect to "EYE".

PROGRAMMING THE REMOTE RECEIVER

These instructions apply to the current 433 MHz configuration of the remote and receiver (RR version 2). For older versions refer to the Apex Service Manual listed on the inside of the front cover.

1. Power to the control box must be on.
2. Press and release the "Press to Learn Transmitter" button on the bottom of the receiver box. The receiver is in program mode when the red light comes on.
3. Press and release the stop button on the remote. The red light will go out after the receiver learns the remote signal.

NOTE: For single awning key FOB remotes: Pressing the stop button will cause the blue up arrow button to default as the open (extend) function. If a function button is pressed to train the receiver, it will be programmed as the open (extend) button. Example: Pressing the bottom button will program the bottom button for extend and the top button as retract.

4. Repeat for each additional remote.

OPERATIONAL NOTES:

- Transmitter and receiver operate on a frequency of 433 MHz.
- The receiver exits the program mode after ten seconds.
- If the light does not come on above, the memory is full and must be cleared. If the light still does not come on, check the continuity of the cord between the boxes and repair or replace as required. Pin 1 of the 1st connector goes to pin 1 of the 2nd connector etc.
- If the light does not go out in above, the receiver already knows the transmitter's signal or the battery in the remote needs to be replaced.
- To clear the memory: PRESS AND HOLD the transmitter learn button. While holding the button, the indicator light should be OFF for the full 5 seconds then come on.
- The system may be programmed for up to 5 remotes. Additional remotes may be ordered separately.

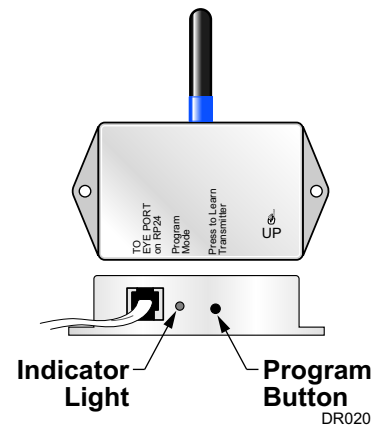

IGNITION LOCKOUT SENSOR INSTALLATION (OPTIONAL)

Two ignition lockout sensors are available with the Direct Response System.

- The STD ignition lockout module disables the extend function when the module receives a current through a switched 12VDC circuit.
- The RTL ignition lockout module will fully retract the awning and disable the extend function when the module receives a current through a switched 12VDC circuit.

A switched 12VDC source is a line that is "hot" when the ignition switch is in the on position; or, a 12VDC circuit through a relay that is "hot" when a specific condition is met (i.e. releasing the parking brake). Relays are not furnished.

1. Disconnect power to the awning. Shut off the power source or pull the appropriate circuit breaker.
 2. Locate the control box for the Direct Response System.
 3. Open the cover of the control box.
 4. For Single Awning Applications:
 - 4.1. Disconnect the remote receiver cable from the "EYE" port in the control box. Do not disconnect the cable from the receiver box.
 - 4.2. Connect the supplied 6" cable to "EYE" port in the control box.
 - 4.3. Attach the splitter to the other end of the cable.
 - 4.4. Plug the cable from the remote receiver into the splitter.
 - 4.5. Attach the Lock-Out Sensor to the end of the 60" cable. Route the cable as desired and connect the cable to the splitter.
 - 4.6. Proceed to step 6.
 5. For Multiple Awning Applications:
 - 5.1. The module may be connected to the control box as described for single awning applications.
OR
 - 5.2. The module may be directly connected to any open "EYE" port on any of the control boards. It is not necessary to use the short cable or splitter.
 - 5.3. Proceed to step 6.
- NOTE:** Wires to the module are not pin specific.
6. Attach one 18-gauge wire to a terminal of the sensor and route the wire to a suitable 12VDC ground.
 7. Attach a second 18-gauge wire to the second terminal of the sensor and route the wire to a SWITCHED 12VDC source.
 8. Bundle and secure the sensor, cable and wires as required.
 9. Reattach the control box cover.

WIRING DIAGRAM – SINGLE AWNING

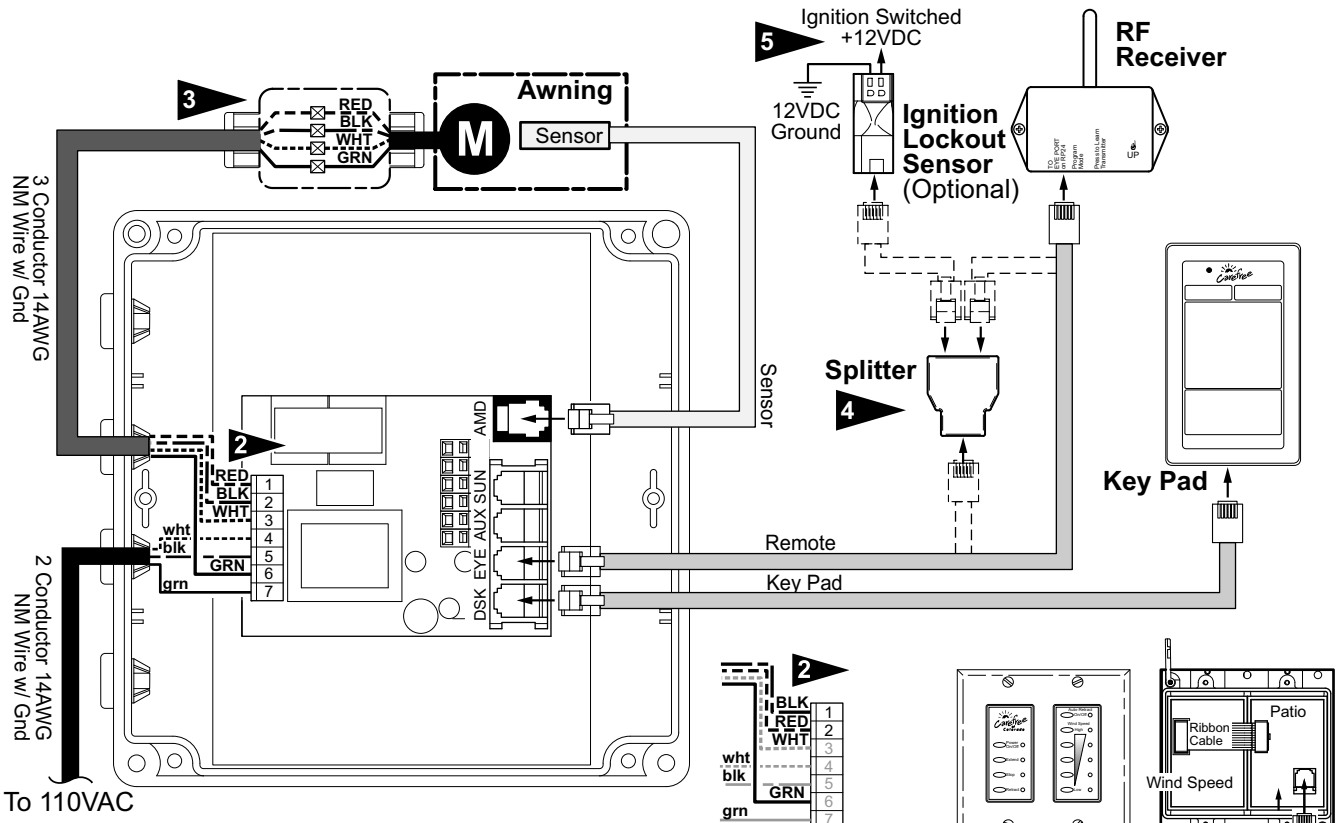

NOTES:

- 1 Wire Legend:
 - Red
 - Black
 - White
 - Green (Ground)
- 2 For LH Motor Configurations:
 Motor Red goes to Pin (1); Motor Black goes to Pin (2)
 For RH Motor Configurations:
 Motor Red goes to Pin (2) Black; Motor Black goes to pin (1)
- 3 The SO cable from the 110VAC awning motor can only pass through a wall, it cannot be laid up in the wall and must be connected to NM wire or individual wires in conduit no more than 6 inches past the point of entry.
- 4 Splitter is used only when Optional Lock-Out Sensor is installed. Connect RF Receiver directly to "EYE" if Lock-Out is not installed.
- 5 Wires for the Ignition Lock-Out Sensor are not pin specific.

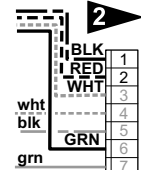

Detail A
For RH Configuration
Reverse Red & Black Wires

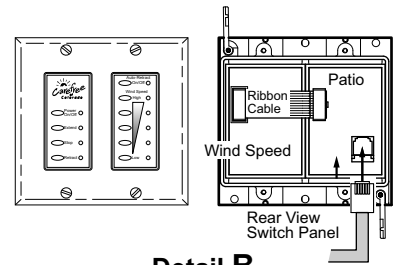

Detail B
Used thru 2006

DR012

FROM		To (RH CONFIGURATION)		To (LH CONFIGURATION)	
Motor	Black	Control Box	1	Control Box	2
	Red		2		1
	White		3		3
	Ground		6		6
AC Power Source	White	Control Box	4	Control Box	4
	Black		5		5
	Ground		7		7
Awning Sensor	10' Cable	Control Box	"AMD"	Control Box	"AMD"
Key Pad	60" Cable	Control Box	"DSK"	Control Box	"DSK"
Splitter	60" Cable	Control Box	"EYE"	Control Box	"EYE"
RF Receiver	60" Cable	Splitter		Splitter	
Ignition Lockout	60" Cable	Splitter		Splitter	

Notes: 1. Cable lengths are the lengths of the furnished cables. If a connection requires a length greater than the supplied cable, the installer must provide a terminated jumper cable from the box location to the cable end.

WIRING DIAGRAM - 2-AWNINGS

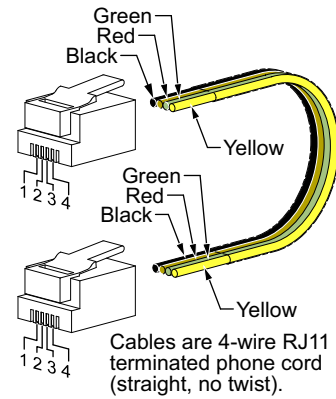
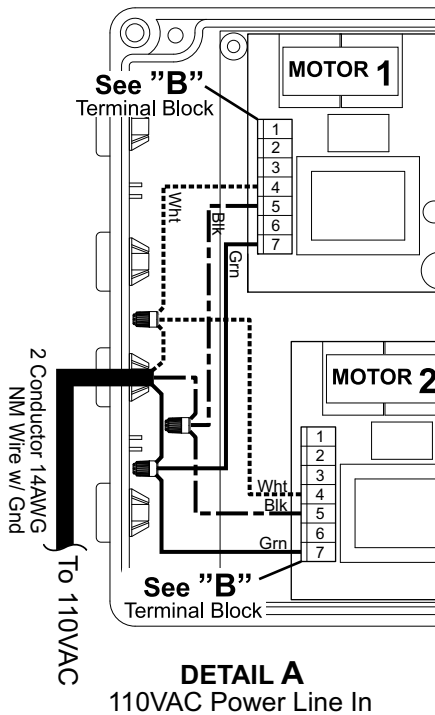
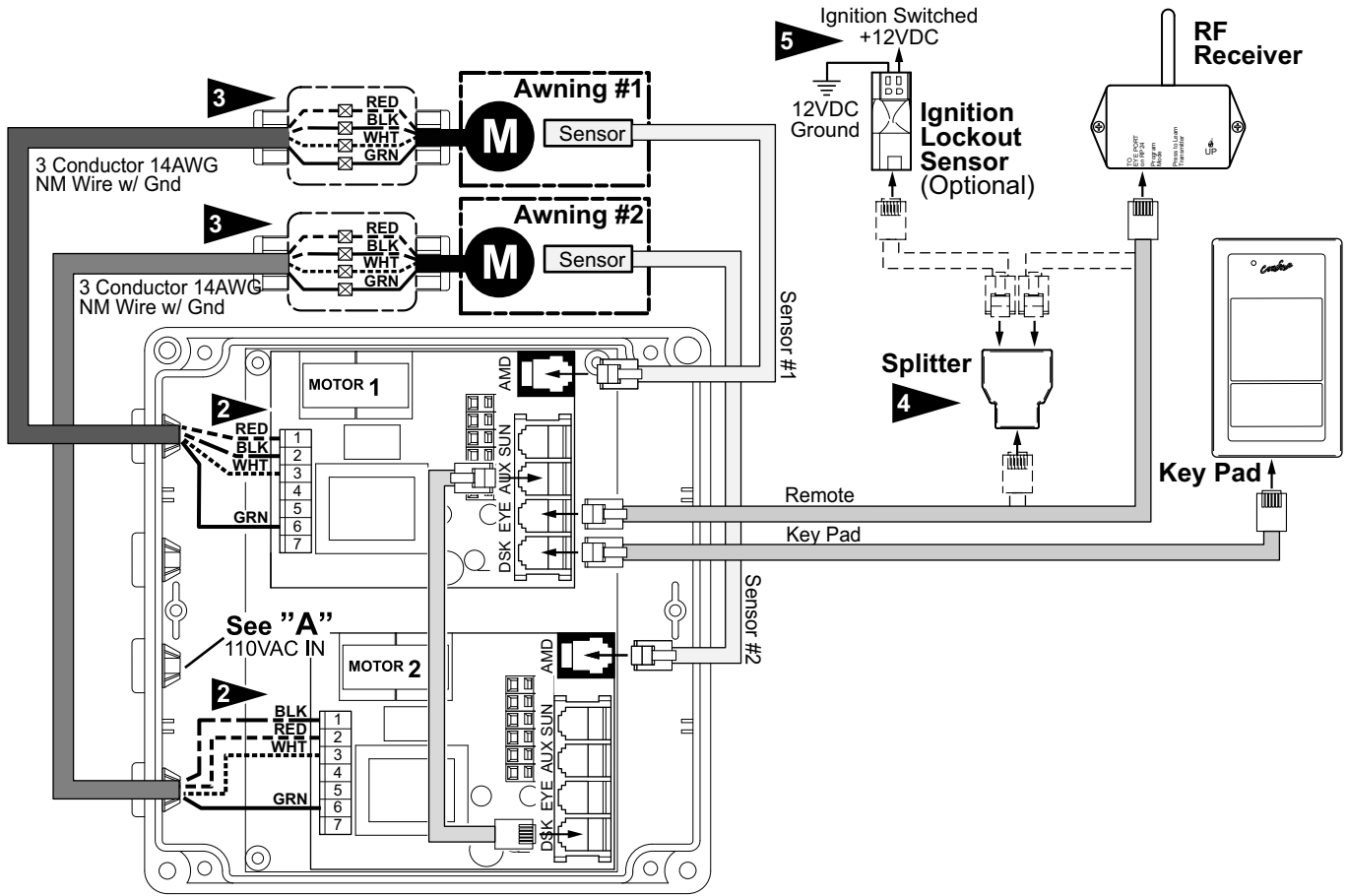



DR014

NOTES:

- 1  Wire Legend
- Red
 - Black
 - White
 - ===== Green (Ground)

- 2  Awning #1 shown as LH Motor, Awning #2 shown as RH Motor
- For LH Motor Configurations:**
Motor Red goes to Pin (1); Motor Black goes to Pin (2)
- For RH Motor Configurations:**
Motor Red goes to Pin (2); Motor Black goes to Pin (1)

- 3  The SO cable from the 110VAC awning motor can only pass directly through a wall; it cannot be laid up in the wall and must be connected to NM wire or individual wires in conduit no more than 6" past the point of entry.

- 4  Splitter is used only when Optional Lock-Out Sensor is installed. Connect RF receiver directly to "EYE" if Lock-Out is not installed.

- 5  Wires for Ignition Lock-Out Sensor are not pin specific.

- 6  For screw type terminals: After testing connections, use Loctite 29005 or equivalent to secure screws in terminal block

- 7  Cables are 4-wire RJ11 terminated phone cord (straight, no twist).

- 8  Terminal block designations are for reference only. Actual boards may not be marked.

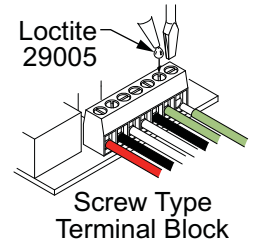

FROM		To CONTROL BOARD		
		MOTOR #1	MOTOR #2	
AC Power Source	White	4	4	
	Black	5	5	
	Ground	7	7	
Awning #1 Motor	Black	Refer to Flag Note 2		
	Red			
	White			3
	Ground			6
Awning #2 Motor	Black		Refer to Flag Note 2	
	Red			
	White			3
	Ground			6
#1 Sensor	10' Cable	"AMD"		
#2 Sensor	10' Cable		"AMD"	
Key Pad	25' Cable	"DSK"		
Splitter	60" Cable	"EYE"		
RF Receiver	60" Cable	Splitter		
Ignition Lockout	60" Cable	Splitter		

- Notes:
1. Splitter is used w/ Ignition Lock-Out only. If Lock-Out is not installed, connect the receiver directly to "EYE".
 2. Cable lengths are the lengths of the furnished cables. If a connection requires a length greater than the supplied cable, the installer must provide a terminated jumper cable from the box location to the cable end.

WIRING DIAGRAM - 4 AWNINGS

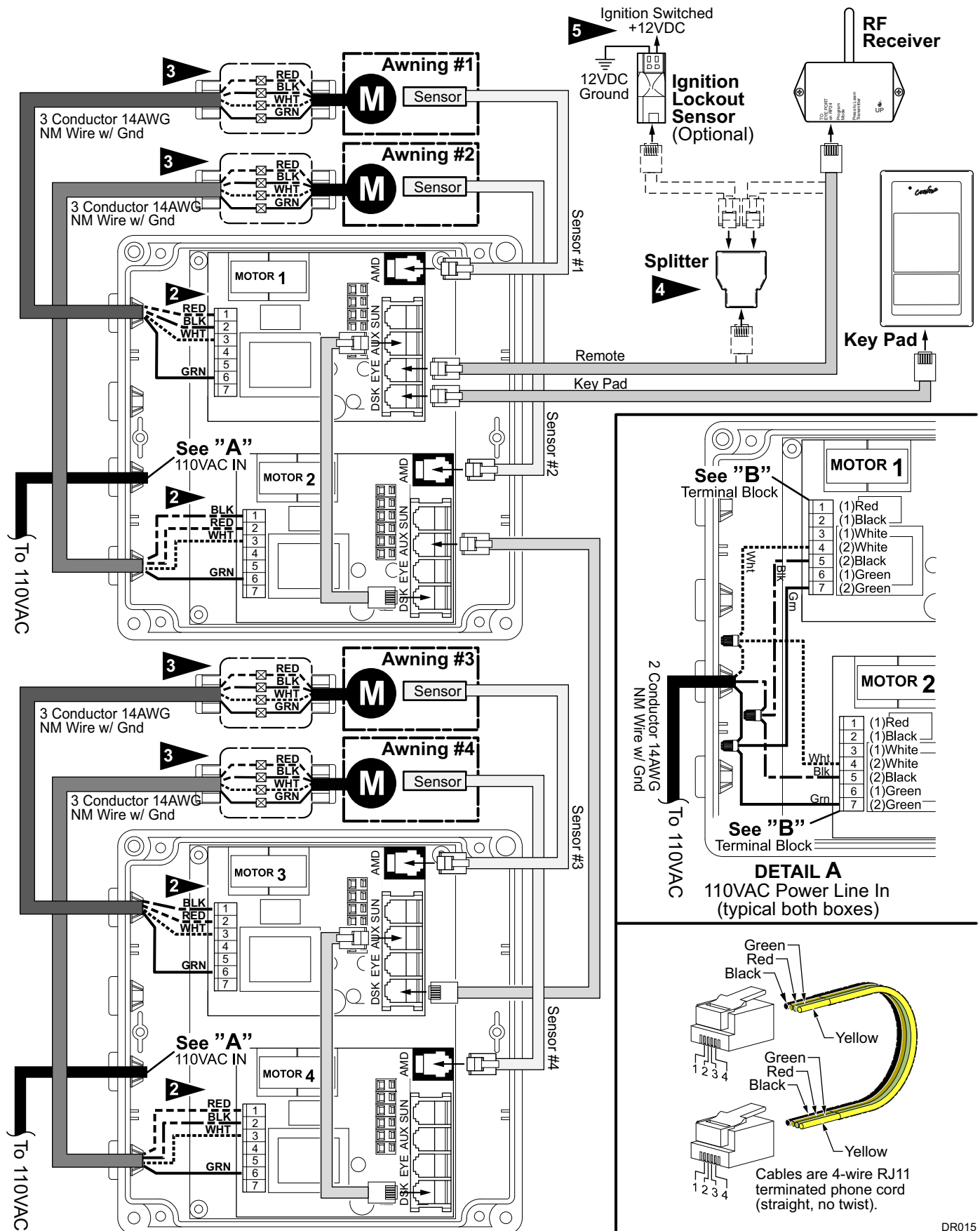

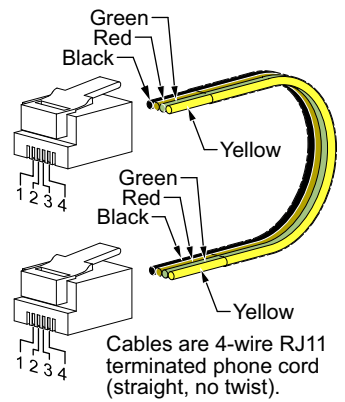

DETAIL A
110VAC Power Line In
(typical both boxes)





DR015

NOTES:

- 1  Wire Legend
- Red
 - Black
 - White
 - ===== Green (Ground)

- 2  Awnings #1 & #4 shown as LH Motor, Awnings #2 & #3 shown as RH Motor
- For LH Motor Configurations:**
Motor Red goes to Pin (1); Motor Black goes to Pin (2)
- For RH Motor Configurations:**
Motor Red goes to Pin (2); Motor Black goes to Pin (1)

- 3  The SO cable from the 110VAC awning motor can only pass directly through a wall; it cannot be laid up in the wall and must be connected to NM wire or individual wires in conduit no more than 6" past the point of entry.

- 4  Splitter is used only when Optional Lock-Out Sensor is installed. Connect RF receiver directly to "EYE" if Lock-Out is not installed.

- 5  Wires for Ignition Lock-Out Sensor are not pin specific.

- 6  For screw type terminals: After testing connections, use Loctite 29005 or equivalent to secure screws in terminal block

- 7  Cables are 4-wire RJ11 terminated phone cord (straight, no twist).

- 8  Terminal block designations are for reference only. Actual boards may not be marked.

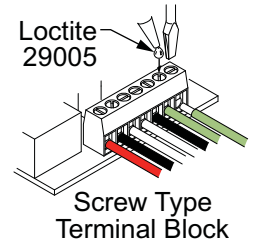

FROM		TO CONTROL BOARD				
		MOTOR #1	MOTOR #2	MOTOR #3	MOTOR #4	
AC Power Source	White	4	4	4	4	
	Black	5	5	5	5	
	Ground	7	7	7	7	
Awning #1 Motor	Black	Refer to Flag Note 2				
	Red					
	White					3
	Ground					6
Awning #2 Motor	Black		Refer to Flag Note 2			
	Red					
	White					3
	Ground					6
Awning #3 Motor	Black			Refer to Flag Note 2		
	Red					
	White					3
	Ground					6
Awning #4 Motor	Black				Refer to Flag Note 2	
	Red					
	White					3
	Ground					6
#1 Sensor	10' Cable	"AMD"				
#2 Sensor	10' Cable		"AMD"			
#3 Sensor	10' Cable			"AMD"		
#4 Sensor	10' Cable				"AMD"	
Key Pad	25' Cable	"DSK"				
Splitter	60" Cable	"EYE"				
RF Receiver	60" Cable	Splitter				
Ignition Lockout	60" Cable	Splitter				

- Notes:
1. Splitter is used w/ Ignition Lock-Out only. If Lock-Out is not installed, connect the receiver directly to "EYE".
 2. Cable lengths are the lengths of the furnished cables. If a connection requires a length greater than the supplied cable, the installer must provide a terminated jumper cable from the box location to the cable end.

CONNECTION FLEX W/ "110VDR" CONTROL BOXES

The wiring diagrams show the standard installation for multiple awning configurations. For control boxes marked w/ "110VDR", the installer may adjust the cable interconnections for greater flexibility during installation.

1. The key pad may be installed in the unused DSK port of any board with the jumper cables sequentially connected from the AUX port to the DSK port of the next board.

Example: Placing the keypad in the DSK of Board 3.

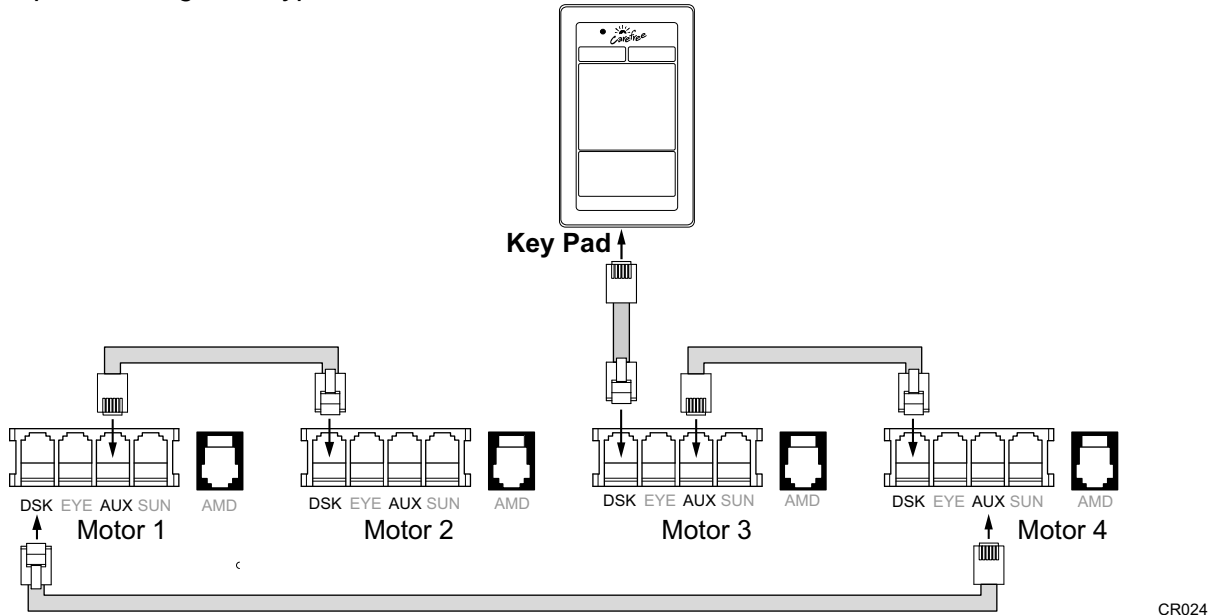

2. The RF Receiver and the optional ignition lock-out can be plugged into any unused "EYE" port. It is not necessary to use the splitter as shown in the diagrams.
3. The "110VDR" control boxes are compatible with integrator interfaces. Contact Carefree engineering for information and system requirements.

OPTIONAL MANUAL BYPASS SWITCH

Installers may elect to install a manual bypass switch for testing or emergency operation of the awning. The simple switch allows the operator to extend or retract the awning without using the keypad control panel. For multiple awning installations, a separate switch must be installed for each awning.

1. Open the control box and identify the terminal block next to the phone cord jacks.
2. Connect the switch to the terminal block as shown in the diagram.

The switch is a single pole, double throw, momentary ON, center OFF. Components are installer furnished.

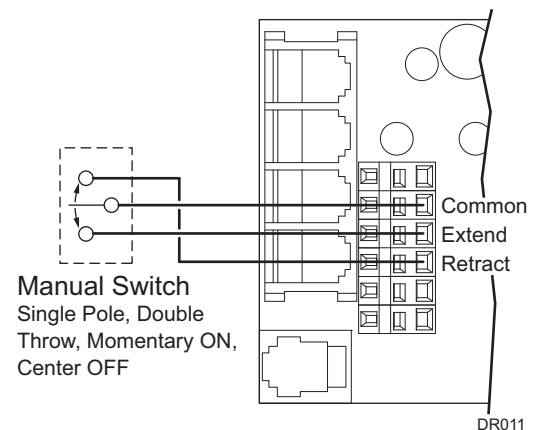

OPTIONAL LED LIGHTING SWITCH INSTALLATION

An optional factory installed LED light strip is available for the Apex awning. The strip is mounted in the lead rail; the harness is routed through the awning with the Direct Response cable.

For multiple awning installations, each LED strip may be attached to an individual switch or two LED strips can be hooked in parallel to a single switch.

NOTE: Installers may choose to furnish the control switch. The installation requires that the power line (+12VDC) be attached to a dedicated 2A circuit breaker or a 2A in-line fuse must be installed between the switch and power source. For easy access, locate the fuse close to the switch.

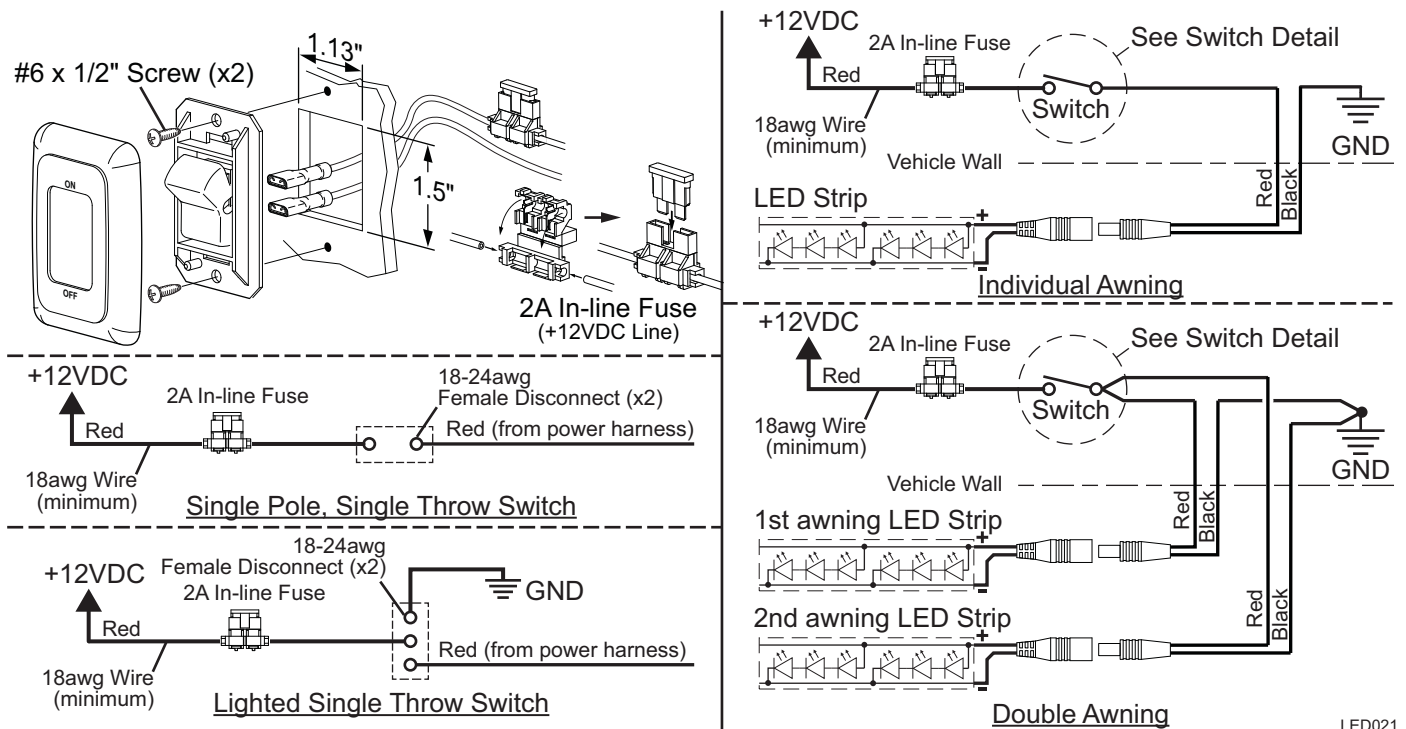

1. Route the harness into the vehicle with the Direct Response cable and the motor power cable.
 2. Determine the location of the switch.
 3. At the switch location, cut a 1 1/8" x 1 1/2" hole.
 4. Wire the switch as shown below. Wire terminals at the switch are .187, 18-24 awg female disconnects.

NOTE: Allow adequate slack in the 12VDC power line so that the in-line fuse (installed in step 5) can be accessed from behind the switch.
 5. Install the in-line fuse:
 - 5.1. Near the switch, cut the red 12VDC power line to the switch. Do not strip the insulation.
 - 5.2. Insert a wire end into one of the wire channels until it butts up against the stop.
 - 5.3. Fold that half of the connector body over until the element contacts the wire. Use pliers to crimp the connector closed.
 - 5.4. Repeat for the second wire end.
 - 5.5. Slide the fuse into the fuse port. Ensure that is firmly seated.
 6. Press the in-line fuse, wires and switch into the mounting hole. Secure the switch using two (2) #6 x 1/2" screws.
 7. Snap the switch bezel over the switch frame.
- Kit SR0101 is available from Carefree and includes switch, fuse holder and 2A fuse.

STANDARD SYSTEM ADJUSTMENTS

ADJUSTING THE PITCH

The awning is factory set with minimum pitch. The amount of adjustment for increasing pitch may be limited by the mounting height above a door opening. The diagram chart below provides the minimum distance required above an opening with a swing-out door or window when the awning is set at MINIMUM and MAXIMUM pitch:

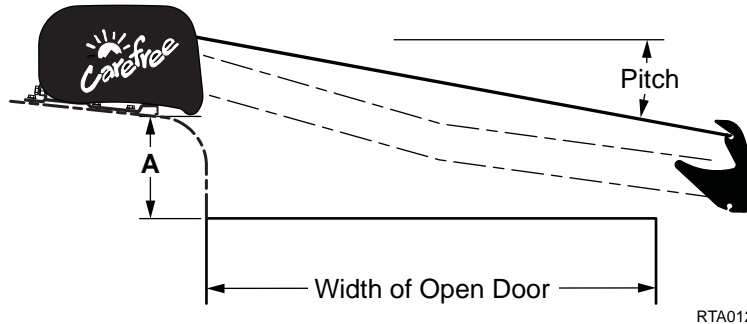

Door Width	0"	12"	18"	24"	30"	36"
A @ MINIMUM PITCH	1"	1.25"	1.5"	1.75"	2"	2.5"
A @ MAXIMUM PITCH	1"	3.5"	5.25"	7"	8.75"	10.5"

NOTE:

1. Minimum Height (A) is measured from the door opening to the bottom of the mounting plate. The value given is a minimum requirement.
2. Dimensions are based on a 6° roof pitch

NOTICE During installation or when the pitch of the awning is adjusted, it is important that the lead rail is parallel to the awning housing.

1. Extend the awning fully.
2. On one end, loosen the 6mm hex screw located on the spring arm knuckle.
3. SLIGHTLY loosen the 3/4" nut on the side of the knuckle.
4. Turn the 3/4" adjustment nut located on the bottom of the knuckle. CLOCKWISE raises the pitch, COUNTERCLOCKWISE lowers the pitch.
5. Repeat steps 2 through 4 for the other end.
6. When the pitch adjustments are completed, tighten the 6mm screw and the 3/4" nut on the side of the knuckle.

NOTE: When raising the pitch, it is helpful to have a second person lift up on the lead rail.

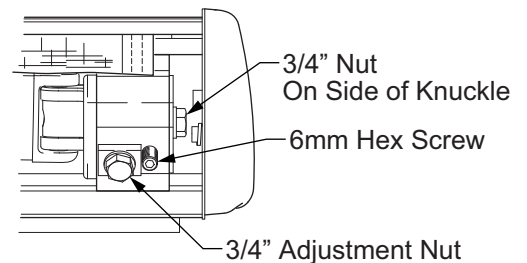

DETAIL A

When the pitch is adjusted, it is necessary to adjust the angle of the lead rail for the awning to close correctly. (refer to Detail B)

7. SLIGHTLY loosen the 3/4" nut on the side of each arm knuckle on the lead rail.
8. Turn the INSIDE 6mm hex screws of each knuckle to increase or decrease the angle of the lead rail. The bottom of the lead rail should be parallel with the ground.
9. When the lead rail adjustments are completed, tighten the 3/4" nut on the side of the knuckles.

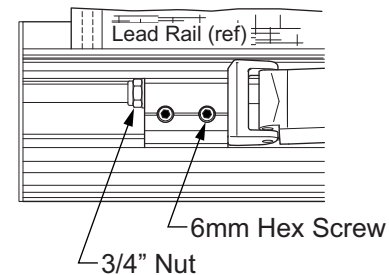

DETAIL B

RTA013

SETTING THE MOTOR LIMITS

The motor limit switches are preset at the factory for best operation. The "OUT" limit switch is used to stop the motor when the awning is fully extended. The "IN" limit is NOT USED with the *Direct Response* system.

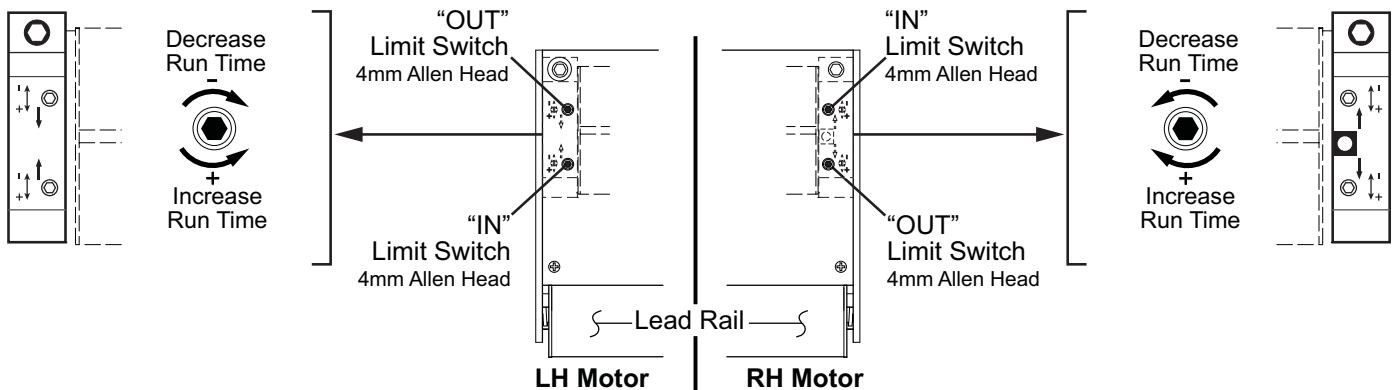

The limit switches are located inside the case, near the end plate. To access the switches, remove the rubber plugs on top of the case next to the end plate.

Paramount014a

Adjusting the OUT Limit Switch

NOTE: During normal operation, the awning will extend out then roll back slightly to tension the fabric.

1. Extend the awning out completely.
2. Confirm that the arms are fully extended. The motor should stop and the fabric should be tight. If the motor continues to run, the fabric will sag; or, if the motor quits before the arms are fully extended, it will be necessary to adjust the "OUT" limit switch.

NOTE: It is best to make the adjustments in increments of a single turn. 3 full turns of the screw equals approximately 2" of fabric extension.

3. If the fabric sags:
 - 3.1. Retract the awning until the fabric is tight then retract an addition 10"-12".
 - 3.2. Using a 4mm Allen wrench turn the "OUT" limit switch COUNTERCLOCKWISE to reduce the time the motor runs.
 - 3.3. Extend to confirm that the adjustment is correct.
 - 3.4. Repeat the procedure until the awning extends correctly.
4. If the arms do not extend completely:
 - 4.1. Retract the awning approximately 10"-12".
 - 4.2. Using a 4mm Allen wrench turn the "OUT" limit switch CLOCKWISE to increase the time the motor runs.
 - 4.3. Extend to confirm that the adjustment is correct.
 - 4.4. Repeat the procedure until the awning extends correctly.

Adjusting the IN Limit Switch

NOTE: The "IN" limit switch is not adjusted with the Direct Response system. The system electronics monitors the motor and shuts the motor off when the awning is fully retracted.

If the IN limit switch is accidentally adjusted, the motor may shut off before the awning is fully closed. If this occurs, turn the "IN" adjustment screw to INCREASE the motor run time. It is not necessary that the screw matches the closed position.

NOTE: It is normal for the lead rail to slightly relax after the awning closes completely.

MANUAL OVERRIDE

If 110V power is not available to the coach, the Apex awning can still be safely retracted using the manual override.

1. The bypass is located inside the case, near the end cap. Remove the large rubber plug located toward the rear of the case on the motor side of the awning.
2. Chuck the 7mm hex key into a 3/8" battery powered drill.
3. Insert the hex key into the manual override on the awning.
4. Operate the drill in the direction shown in the diagram to close the awning. Reverse the drill to open the awning.
5. When done, reinsert the rubber plug.

