



RV

OWNER'S MANUAL

FREESTYLE WM AWNING

12V Motorized Lateral Arm Box Awning

with Carefree's BT12 Wireless Awning Control System Using Bluetooth® wireless technology



Before operating the awning, carefully review the Owner's Manual. The manual contains important safety information, detailed operating instructions, common maintenance and other useful information.



TABLE OF CONTENTS

Introduction	2
Operation	6
Standard Switch Operation.....	6
Ignition Lockout	6
BT Motion Sensor.....	7
Options.....	9
BT Remote	9
LED's.....	10
Setting the System into Pairing Mode	11
Carefree Connects Mobile App	11
FAQs.....	13
The Indicator Light Blinks on the Control Box.....	13
The System Beeps and the Awning Retracts.	13
The Remote Does Not Work	13
Manual Override	14
Awning Care	15
Fabric Care.....	15
Arm Noise.....	16
Pitch Adjustment	16
Carefree Major Product Limited Warranty.....	17

INTRODUCTION

Thank you for your recent purchase of the Longitude awning. We appreciate having the opportunity to do business with you. Our customers are our top priority, and we strive for 100% satisfaction. If you have any questions or concerns about this product, please do not hesitate to contact us.

Check with your dealer to discover the products that can make your life more Carefree.

The Carefree Freedom Freestyle WM awning is state of the art with lateral support arms that provides strength and functionality without interfering with coach sidewalls, custom graphics or equipment that may be mounted on the sidewalls.

- When retracted, the housing provides protection against the elements while the streamlined styling blends in with the RV sidewall and is a perfect complement to other Carefree products.
- The awnings are made with heavy duty construction with an all metal chassis.
- The BT12 Wireless Control System with Bluetooth® wireless technology offers unique features not available with a standard awning installation.
 - Carefree Connects Mobile App – The app provides full and enhanced control of the awning using a smart phone or tablet. The free app can be downloaded on any devices that support: 1) Current iOS or Android operating systems, and 2) Bluetooth low energy technology.
 - Full Retract – When the awning is retracted, it retracts completely. It is not necessary to hold the button when closing the awning.
 - Full Extend – When the awning is extended, it extends completely. It is not necessary to hold the button when opening the awning.
 - Auto-Retract – The awning can be set to automatically close when windy conditions occur with the optional BT Motion Sensor.
 - Remote Control – The operator can conveniently operate the awning from any location with the optional BT Remote key FOB.

Special Note: This manual provides a basic description of the product and the standard operating controls provided by Carefree of Colorado. Some Original Equipment Manufacturers (OEM's) may alter or change the placement, style and/or functional configuration of the switches. If your controls do not match the style or description included, contact the coach manufacturer for an accurate description.

NOTICES AND DISCLAIMERS

TRADEMARKS

The **Bluetooth®** word mark and logos are registered trademarks owned by the Bluetooth SIG, Inc. Use of such marks by Carefree of Colorado is under license.

Other trademarks and trade names are those of their respective owners.

STATEMENTS OF COMPLIANCE

- BT12 Control Module
- BT Motion Sensor
- BT Remote

FCC and IC identification numbers are located on the exterior surfaces of the individual components.

FCC COMPLIANCE

These devices comply with Part 15 of the FCC rules. Operation is subject to the following two conditions: (1) These devices may not cause harmful interference and, (2) These devices must accept any interference received, including interference that may cause undesired operation.

NOTE: This equipment has been tested and found to comply with the limits for a Class B digital device, pursuant to part 15 of the FCC rules. These limits are designed to provide reasonable protection against harmful interference in a residential installation. This equipment generates, uses and can radiate radio frequency energy and, if not installed and used in accordance with the instructions, may cause harmful interference to radio communications. However, there is no guarantee that interference will not occur in a particular installation. If this equipment does cause harmful interference to radio or television reception, which can be determined by turning the equipment off and on, the user is encouraged to try to correct the interference by one or more of the following measures:

- Reorient or relocate the receiving antenna.
- Increase the separation between the equipment and receiver.
- Connect the equipment into an outlet on a circuit different from that to which the receiver is connected.
- Consult the dealer or an experienced radio/TV technician for help.

Any changes or modifications not expressly approved by the party responsible for compliance could void the user's authority to operate the equipment.

IC COMPLIANCE

These devices comply with Industry Canada license-exempt RSS standard(s). Operation is subject to the following two conditions: (1) These devices may not cause harmful interference and, (2) These devices must accept any interference received, including interference that may cause undesired operation.

Ces appareils sont conformes aux normes RSS exonérées de licence d'Industrie Canada. L'opération est soumise aux deux conditions suivantes: (1) Ces appareils ne doivent pas causer d'interférences nuisibles et, (2) Ces appareils doivent accepter toute interférence reçue, y compris les interférences pouvant entraîner un fonctionnement indésirable.

Carefree of Colorado

FCC/IC RADIATION EXPOSURE STATEMENT

- BT12 Control Module
- BT Motion Sensor

This equipment complies with FCC and IC radiation exposure limits for an uncontrolled environment. The minimum distance between the radiator and people is designed to be 20cm when installed and operated.

Cet équipement est conforme aux limites d'exposition aux radiations FCC et IC pour un environnement non contrôlé. La distance minimale entre le radiateur et les personnes est de 20 cm lorsqu'installé et utilisé.

- BT12 Remote

This equipment complies with FCC and IC radiation exposure limits for an uncontrolled environment. The minimum distance between the radiator and people is designed to be 5mm when operated.

Cet équipement est conforme aux limites d'exposition aux radiations FCC et IC pour un environnement non contrôlé. La distance minimale entre le radiateur et les personnes est de 5 mm lors de l'utilisation.

DISCLAIMERS

The Freedom Freestyle WM awning, BT12 Wireless Awning Control System and the Carefree Connects Mobile App are products of Carefree of Colorado, located in Broomfield, Colorado, USA. The information contained in or disclosed in this document is considered proprietary to Carefree of Colorado. Every effort has been made to ensure that the information presented in the document is accurate and complete. However, Carefree of Colorado assumes no liability for errors or for any damages that result from the use of this document.

The information contained in this manual pertains to the current components and software listed on the title page. Carefree of Colorado reserves the right to cancel, change, alter or add any parts and procedures, described in this manual, without prior notice.

Carefree of Colorado agrees to allow the reproduction of this document for use with Carefree of Colorado products only. Any other reproduction or translation of this document in whole or part is strictly prohibited without prior written approval from Carefree of Colorado.

SERVICE AND SUPPORT

	www.carefreeofcolorado.com www.carefreeofcolorado.com/carefreeconnects
	customerservice@carefreeofcolorado.com
	Carefree of Colorado 2145 W. 6th Ave. Broomfield, CO 80020

WARNINGS AND CAUTIONS



This is the safety alert symbol. It is used to alert individuals to potential personal injury hazards. Obey all safety messages that follow this symbol to avoid possible personal injury or death.



WARNING This product can expose you to chemicals including Di-isodecyl phthalate (DIDP), Vinyl Chloride and Formaldehyde, which are known to the state of California to cause cancer or birth defects or other reproductive harm. For more information visit www.P65warnings.ca.gov



WARNING Risk of fire. Keep all sources of heat and flame away from the awning canopy. Fabric is NOT fireproof.

NOTICE

Awnings are designed to provide shade and protection from the sun. The effects of wind and rain on an awning are unpredictable and can cause severe damage to the awning and/or the vehicle. If wind or extended periods of rain are expected, roll up the awning.

NOTICE

It is recommended that if leaving the RV unattended for a length of time, retract the awning to avoid unexpected weather conditions.

NOTICE

The Freestyle WM awning is a free-standing (self-supporting) lightweight awning with auto retraction. Do not hang items from the awning or use tie down devices. Use of such objects can cause serious damage to the awning that is not covered by warranty.

NOTICE

If installed, LED lighting must be turned off when the awning is in the rolled up position. This is to prevent possible damage to the LEDs and/or canopy.

NOTICE

When the awning is in the retracted (rolled up) position, shut off the power switch to avoid accidentally extending the awning. For safety, the power switch must be turned off before moving the RV.

CALIFORNIA PROPOSITION 65



WARNING This product contains chemicals known to the state of California to cause cancer or birth defects or other reproductive harm. California's Proposition 65 requires this warning to be given to customers in the state of California.

Additional Cautions and Notices are included in the text for the proper operation of the awning.

OPERATION

The BT12 Wireless Awning Control System offers multiple methods of operating the awning: standard switch operation, the Carefree Connects Mobile App (see page 11) and the BT Remote (see page 9).

STANDARD SWITCH OPERATION

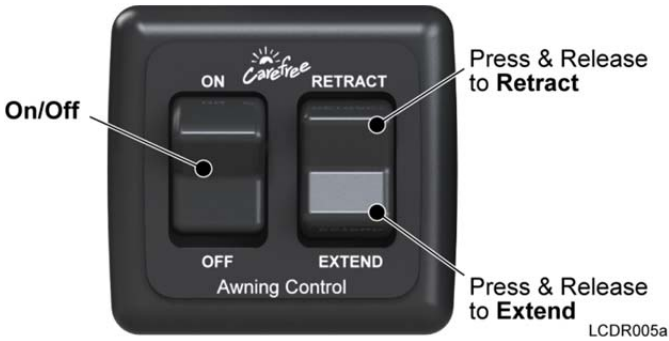

To Operate the Awning:

- Press the power switch to ON.
- **IMPORTANT NOTE:** The power switch must be on for the extend/retract functions to be active using the standard switch operation, the Carefree Connects Mobile App and the BT Remote. The optional BT Motion Sensor is disabled when the switch is OFF.
- To OPEN: Press and release the extend switch. The awning will open completely. To interrupt the awning motion, press and release the extend switch again. The awning will stop.
- To CLOSE the awning: Press and release the retract switch. The awning will close completely. To interrupt the awning retraction, press and release the retract switch again. The awning will stop.
- When the awning is in the retracted (rolled up) position, shut off the power switch to avoid accidentally extending the awning.

IGNITION LOCKOUT

The BT12 Control System provides two options for transportation safety using ignition lockout.

Standard - The system disables the extend function while the vehicle ignition key is in the ON position.

RTL – The system fully retracts the awning and disables the extend function when the vehicle ignition key is in the ON position.

Functions will return to normal operation when the ignition key is turned OFF.

Contact your vehicle dealer to find out if you have the ignition lockout option connected and which version is active in your vehicle.

BT MOTION SENSOR

The BT Motion sensor detects awning motion caused by windy conditions. The sensor is located inside the lead rail on the LH (motor) side.

The system operates by gauging the motion of the awning's front edge (roller tube). When the motion exceeds the factory preset threshold the system retracts the awning. The factory default is "3" on a scale from 1 to 5; 5 being the most sensitive. When using the mobile app, the sensitivity can be adjusted for personal preference.

NOTICE

The Carefree auto retract system is a premier electronic auto-retract system that provides protection against adverse elements; but no auto-retract system is a guarantee against severe or destructive weather; the effects of wind and rain on an awning are unpredictable and may cause severe damage to the awning and/or vehicle. If wind or extended periods of rain are expected, roll up the awning.

NOTE: The auto-retract system is ON when the power switch is ON. The system is OFF when the power switch is set to OFF. If the power is shut off with the power switch while the awning is extended, the awning is not protected by the auto-retract system.

If the motion sensor batteries are low, the awning will beep every 30 seconds (when the power switch is ON) and the awning will partially retract. This will continue until the batteries are replaced. The awning will operate normally after the batteries are replaced.

BATTERY REPLACEMENT – ORIGINAL CONFIGURATION

The motion sensor uses two (2) 675 batteries. Batteries are available at local battery outlets.

1. Open the awning to access the BT12 Motion Sensor.

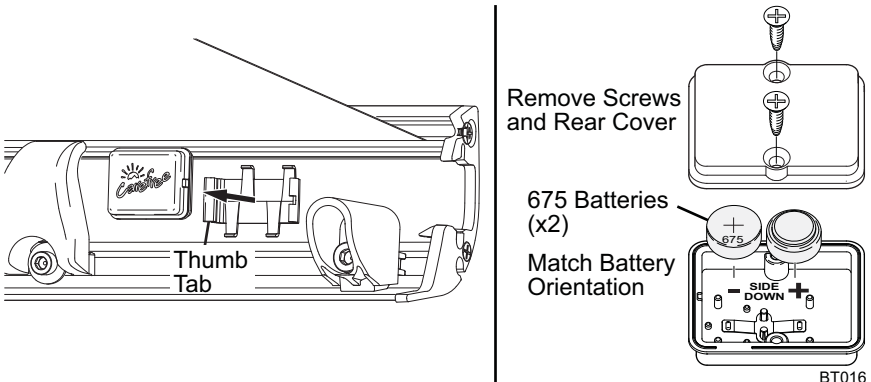

2. Pull the thumb tab of the bracket away from the module and lift the module out of the bracket. It is not necessary to remove the mounting bracket.
3. Remove the two screws and the rear cover.
4. Replace the two batteries. Match the new battery orientation with the old batteries.
5. Replace the cover and screws.
6. Snap the module into the mounting bracket. The module will only fit one way in the bracket.

BATTERY REPLACEMENT – CURRENT CONFIGURATION

The motion sensor uses two (2) “AAA” alkaline batteries. Batteries are available at local battery outlets.

1. Open the awning to access the motion sensor that is located in the lead rail on the motor side of the awning.

Remove Screws and Motion Sensor From Bracket

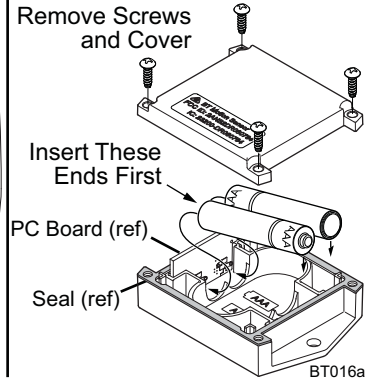
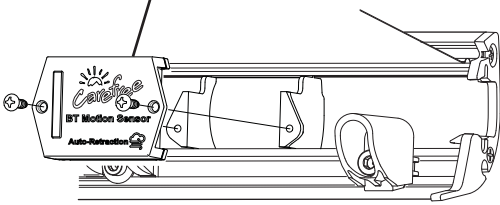

2. Remove the sensor module from the awning.
3. Remove the screws and the rear cover.
4. Remove the two batteries.
5. Make sure that the contact tabs are clean and bent out for best contact.
6. Insert new batteries. Match the new battery orientation with the old batteries.
Tip: Place the battery end next to the PC board first then swivel the other end into the case. This will set the batteries firmly into the case.
7. Check that the seal is in place and flat then attach the rear cover with the screws removed previously.
8. Install the module back in the awning.

OPTIONS

The BT12 Wireless Control System offers several options to enhance your awning experience. OEM's may install these options as a standard offering or can be added to your system at a later date. Contact your Carefree dealer about these options.

BT REMOTE

The optional BT Remote provides the advantage of allowing you to operate the awning from any convenient location.

The remote has an operating range of approximately 30 feet. Actual distance may vary depending on the installation, and proximity of obstacles (such as other vehicles, wall construction etc.)

Extend Press and release the extend button once to activate the extend function (the motor will beep once).

Press and release a second time to extend the awning. The awning will extend out to the full extension and stop automatically.

Retract Press and release. The awning will retract and stop automatically when the awning is fully retracted.

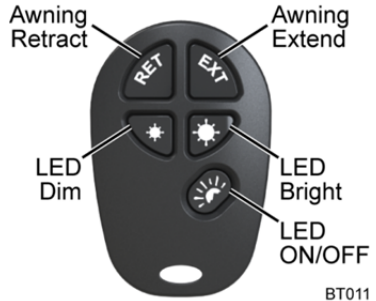

LED Controls

The LED controls are for white LED's wired through the BT12 Control Module.

Turn the awning lights switch to ON (refer to page 9).

The remote ON/OFF button allows you to turn the awning lights on and off (the awning lights switch must be on).

Press and hold the LED Bright/Dim buttons to adjust the LED brightness level.

BATTERY REPLACEMENT

The remote uses one (1) CR2032 battery; batteries are available at local battery outlets.

1. Carefully remove the back cover using a coin in the slot at the bottom corner of the remote.

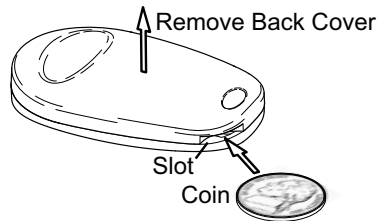

2. Remove the old battery and insert a new battery with the "+" terminal facing up.

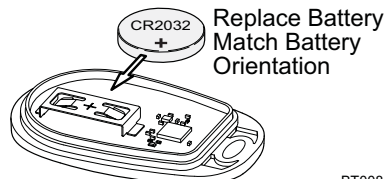

3. Snap the back cover on.

BT008

LED's

White (monotone) LEDs are a popular option providing lighting beneath the awning. Factory installed LEDs are located in the lead rail.

The BT12 Control System provides controls to allow you to set the lights to match your preference with ON/OFF and dimming controls through the Carefree Connects Mobile App and/or the BT Remote.

To operate the White LED lights, you must have the awning lights switch ON.

NOTE: Some OEMs may furnish their own switch that may appear differently than the switch pictured or may have the LED's operated through a multiplexing control center.

The factory default for the lights is full bright. When the light is adjusted with the BT Remote or the mobile app, the system will remember the setting for the next time the lights are turned on.



RGB (CoLoR) LEDs

Select OEMs may offer RGB LEDs. These are NOT controlled through the BT12 Control System.

These lights use a separate IR (Infrared) remote and sensor. The top of the remote must be pointed at the infrared sensor on the control module.

The remote control provides:

- Simple push button on/off
- Adjustable dimming
- 15 color choices + white
- Special effects (flash, strobe, fade and smooth)

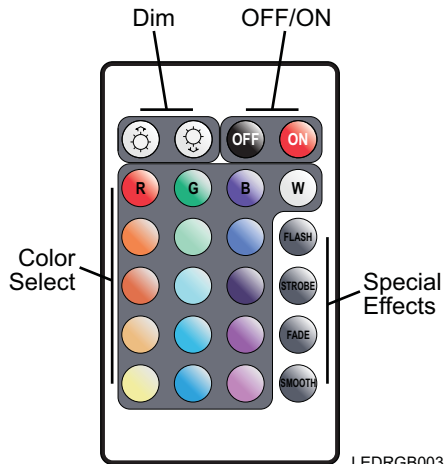

SETTING THE SYSTEM INTO PAIRING MODE

To add peripheral devices (such as remotes or mobile devices) they must be paired to the BT12 Control Module.

There are two methods to set the system into pairing mode.

Using the Awning Retract Function:

1. Turn power to the awning ON.
2. Extend the awning. Note that the awning does not have to be opened completely.
3. Retract the awning.
4. When the awning is fully retracted, press and hold the retract switch for 3 seconds.



Press and hold the retract switch for 3 seconds after the awning has fully retracted.

BTA001b

Using the Switches:



Switch is in the "OFF" position

Press the Power Switch "ON"



Press and Hold the Extend Switch

Continue Holding the Extend Switch for 3 seconds

BTA001a

1. Turn the awning power switch to OFF.
2. Press and hold the extend switch.
3. While holding the extend switch, turn the power switch ON.
4. Continue to hold the extend switch for 3 seconds, then release.

NOTES:

- The module will pair to the physically closest unpaired device first. Repeat the pairing steps for each additional device (the module remembers the devices that have been paired).
- Refer to the Carefree Connects Mobile App manual for setting up and pairing a smart device (such as a smart phone or tablet).
- Multiple devices can be paired to the awning up to a maximum of 8 peripheral devices.
 - Only one active BT Motion Sensor can be paired to the BT12 Control Module.
 - Only one active BT Remote can be paired to the BT12 Control Module.
 - Multiple mobile devices (smartphone or tablet) can be paired to the BT12 Module but only 1 can be active at a time.

CAREFREE CONNECTS MOBILE APP



The Carefree Connects Mobile App allows you to interact with your awning(s) from your mobile device. The app provides access to enhanced features and additional options. The mobile app may be used on any device that supports current iOS or Android operating systems and Bluetooth low energy technology.



For personalized operation controls visit your app store for your smart phone or tablet and download the free Carefree Connects Mobile App.

Download the Carefree Carefree Connects Mobile App manual at
www.carefreeofcolorado.com

The Carefree Connects Mobile App provides programmable controls and status readings for:

- Real-time open and close with the touch of a button.
- Power your LED lights ON or OFF and adjust the LED brightness.
- View the health of your awning and review status notifications.
- Name your awning(s). Avoid confusion by having each awning identified with a unique name.
- Adjust the motion sensitivity level for wind retraction (you must have the optional BT Motion sensor installed).
- Multiple devices can be paired to the awning up to a maximum of 8 peripheral devices.

IMPORTANT NOTE: The power switch (see page 6) must be on for the extend/retract functions to be active using the standard switch operation, the Carefree Connects Mobile App and the BT Remote. The optional BT Motion Sensor is disabled when the switch is OFF.

FAQs

THE INDICATOR LIGHT BLINKS ON THE CONTROL BOX.

- The indicator light on the control module shows the function status of the control module.
- Solid ON indicates power is supplied to the control module.
- One long blink and one short blink indicates power and 1 peripheral (i.e. remote or motion sensor) is paired to the module.
- One long blink and multiple short blinks indicates power and multiple peripherals are paired to the module. The number of short blinks is based on the number of peripherals paired.
- The module does not blink for being paired to a mobile device with the Carefree Connects Mobile App.

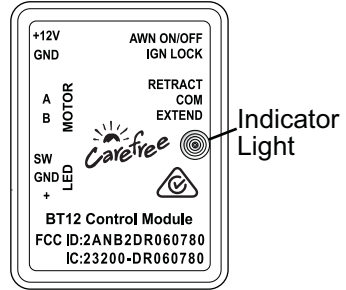

BT023

THE SYSTEM BEEPS AND THE AWNING RETRACTS.

- The motion sensor batteries are low, the awning will beep every 30 seconds (when the power switch is ON) and the awning will partially retract. This will continue until the batteries are replaced. The awning will operate normally after the batteries are replaced. Battery replacement is described on page 7.

THE REMOTE DOES NOT WORK

Confirm that the remote is paired. The module indicator light will blink when peripherals are attached (see description above).

In the mobile app on the “Peripherals Page” confirm that the remote is connected. Green indicates the remote is connected, red indicates device is paired but not connected. No listing indicates the remote has not been paired.

- Remote not paired. Refer to page 11 to pair the device.
- Remote is paired but not active. The remote has an approximate operating range of 30 feet depending on obstructions (such as walls and other vehicles). Move closer to the awning and control module.
- Remote is paired but not active. Batteries need to be replaced. Battery replacement is described on page 9.

MANUAL OVERRIDE

If power to the vehicle is not available, the awning can be safely retracted using the manual override located on the idler (right) end of the case.

NOTE: This procedure cannot be used to extend the awning.

1. Remove the plug from the right endcap and save.
2. Insert a 3/8" socket drive extension and handle into the square drive hole inside the endcap.
3. Turn the handle counterclockwise until the awning is retracted.

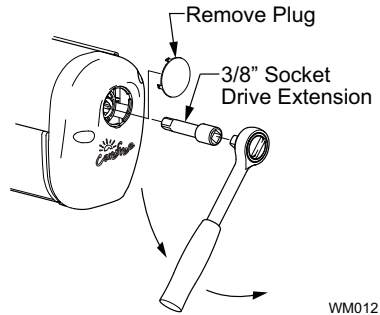

WM012

NOTICE After closing the awning with the manual override, the lead rail may move out from the case 1/4" -1/2". This is normal and the awning is secure for travel until power is restored or repairs are completed. Do not attempt to force the lead rail in with the override, serious damage can occur to the awning.

AWNING CARE

Maintaining a Carefree Awning is easy. Just follow these basic steps:

- Always operate the awning according to the instructions.
- Periodically check that the fasteners are tight. Tighten if necessary.
- Keep the awning fabric and arms clean.

FABRIC CARE

NOTICE Do not use oil based cleaners or any caustic, granulated, or abrasive type cleaners on your Carefree product.

1. One of the best ways to keep the fabric looking good and to delay the need for deep or vigorous cleanings is to hose fabrics off on a monthly basis with clear water. This practice will help prevent dirt from becoming deeply imbedded in the fabric. In most environments, a thorough cleaning will be needed every two to three years.
2. When it's time for a thorough cleaning, the fabric can be cleaned while still on the awning frame.
 - For Vinyl Fabric – Use a soft brush and warm water with soap.
 - For Acrylic Fabric – Use a stiff brush and warm water with soap.
3. When cleaning the fabric, it is important to observe the following:
 - Always use a natural soap, never detergent.
 - Water should be cold to lukewarm, never more than 100°F.
 - Air-dry only. Never apply heat to the fabric.
 - Always allow the fabric to dry thoroughly before rolling up the awning.

MILDEW

Mildew is a fungus growth that looks like dirt. Vinyl coated polyester fabrics are mildew resistant because of a chemical biocide in the vinyl coating. Under ordinary conditions, mildew will not appear. However, in areas where high temperature and humidity are common, mildew can be a problem and require the material to be washed more frequently.

POOLING

When water collects on the top of the fabric, this is known as "pooling". This can occur during inclement weather or if a running air conditioner discharges over the awning. The water is dumped when the awning is retracted. It is recommended that if water accumulates; retract the awning in steps (8"-12") to dump the water. This will help prevent the fabric from stretching or distorting.

LEAKING

On vinyl canopies, side hems and poly cords are stitched in with a sewing machine. On occasion, this stitching may allow water to seep or leak through the stitches. This is normal and not a defect covered by warranty. Treat the seams with a quality seam sealer.

ARM NOISE

After a period of use, the arm knuckle joints may slide together slightly making a squeaking or squealing noise; this is normal and not a reason for concern. To reduce the sound, apply a few drops of multi-purpose oil (3-IN-1®¹ or equivalent) on the knuckle joint seams. Operate the awning and repeat 3-4 times to allow the oil to penetrate into the joint.

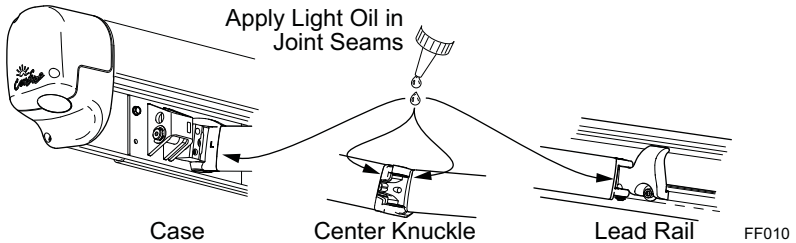

PITCH ADJUSTMENT

The pitch for Freedom Freestyle WM can be adjusted to optimize the awning performance.

NOTICE Use care to not raise the awning pitch to high. This can prevent the lead rail from closing properly. If in doubt, try closing the awning, if the lead rail does not close properly then lower the pitch.

1. Open the awning to access the adjustment screws located on the arm case knuckles.
2. Have a second person lift up on the lead rail to relieve the pressure on the adjustment screws.

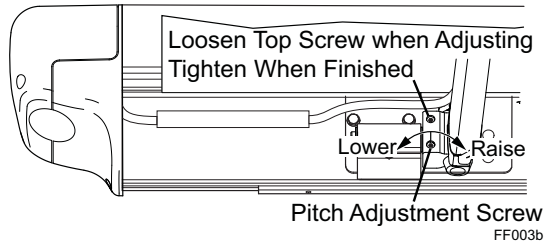

3. Using a 4mm allen wrench, loosen the top screw. Turn the bottom adjustment screw clockwise to raise the lead rail; turn the adjustment screw counterclockwise to lower the lead rail.
4. When the pitch is set at the desired angle, tighten the top screw.
5. Repeat for each arm. Ensure that the lead rail is parallel with the awning case.

NOTE: The Freedom Freestyle WM lead rail self-adjusts to accommodate the pitch. No adjustment is required to the lead rail when the pitch is adjusted.

¹ 3-IN-1® is a registered trademark of the WD-40 company.

CAREFREE MAJOR PRODUCT LIMITED WARRANTY

Carefree of Colorado (hereafter referred to as Carefree) warrants to the first retail Purchaser that the Carefree Product is free of defects in material and workmanship within the terms and conditions as set forth in the warranty statement available online at www.carefreeofcolorado.com. Carefree's obligation under this warranty is limited to the repair or replacement, at Carefree's option, of any defective component with new or factory refurbished components.

OWNER MUST RETAIN THE ORIGINAL PROOF OF PURCHASE AND/OR HAVE THE PRODUCT WARRANTY REGISTRATION ON FILE AT CAREFREE FOR WARRANTY CLAIMS.

THIS WARRANTY IS NOT TRANSFERABLE.

Visit www.carefreeofcolorado.com for

- Warranty Duration;
- Warranty Coverage and Exclusions;
- Warranty Terms of Coverage; and,
- Warranty Claim Procedures

Register your Carefree products on-line at www.carefreeofcolorado.com

IMPORTANT NOTICE: It is strongly recommended that adjustments and repairs not described in this book be performed by trained technicians at your Authorized Carefree Dealer. Work performed by non-authorized persons or businesses may void warranty.

